



MADE IN ITALY



TOP SELECTION GARDEN 2024

CLASSIC RANGE





















MODERN RANGE



SOLAR RANGE



CLASSIC RANGE

	REVIVAL	HEXAGONAL	SQUARE	GLOBES
GARDEN SMALL	<p>ROBY NEW</p>  <p>pag.13</p>	<p>GL250 MODERN NEW</p>  <p>pag.25</p>	<p>ANNA</p>  <p>pag.33</p>	<p>SABA</p>  <p>pag.37</p>
GARDEN MEDIUM	<p>DARIO NEW</p>  <p>pag.17</p>	<p>GL 300 MODERN NEW</p>  <p>pag.29</p>	<p>RUT</p>  <p>pag.49</p>	<p>SALEM</p>  <p>pag.53</p>
GARDEN LARGE	<p>SERGIO NEW</p>  <p>pag.21</p>	<p>NOEMI</p>  <p>pag.69</p>	<p>SILOE</p>  <p>pag.73</p>	<p>TOBIA</p>  <p>pag.77</p>
HALF LANTERN	<p>FABIO NEW</p>  <p>pag.11</p>	<p>ESSE</p>  <p>pag.85</p>	<p>DARIA</p>  <p>pag.85</p>	
BOLLARD	<p>SAURO E27</p>  <p>pag.87</p>	<p>MIRELLA E27</p>  <p>pag.87</p>	<p>SAURO GX53</p>  <p>pag.89</p>	<p>MIRELLA GX53</p>  <p>pag.89</p>



BOLLARD



DOWNLIGHT



UP&DOWN



FLOODLIGHT



IN-GROUND



BRICKLIGHT



BULKHEAD



POST



1L0.000

ALDO

for details see pag.143

CARLO 800

for details see pag.99



DR1.575

2A3.000



MAMETE

for details see pag.121

LIVIA 60

for details see pag.117



1A9.000

TERESA 90

for details see pag.114



3L1.000

AB1.000



ABRAM150

for details see pag.123

MINITOMMY-EL

for details see pag.133



1M2.001

LUCIA

for details see pag.173



1R4.000

DS1.563



ESTER 500

for details see pag.95

MODERN	JOSEPHA pag.185	FIORINA pag.187	FORTUNATO pag.187	FELICE pag.189	SANTINA pag.191	CLASSIC	ROSETTA pag.193
--------	--------------------	--------------------	----------------------	-------------------	--------------------	---------	--------------------

NEW VERSION
SOLAR MODULE



FIORINA
for details see pag.187

F11.542.S3L



JOSEPHA 800
for details see pag.185

JS1.242.S3L0P2



SANTINA 500 SPIKE
for details see pag.191

SL1.259.S3L0P2



FELICE 200
for details see pag.189

FE1.573.S3L0P2



FORTUNATO
for details see pag.187

FO1.000.S3L



BISSO/ROSETTA
for details see pag.193

R22.131.S3L



SAVE UP TO
40%
VOLUME

MADE IN ITALY

SINGLE BOX



SMART PACK



- ✓ SAVE UP TO 40% VOLUME
- ✓ ECO-FRIENDLY PACKAGING
- ✓ FILM WRAPPED ITEMS

AVAILABLE FOR:

FABIO pag.11	IESSE pag.85	TERESA 90 pag.114	FRANCY pag.131	FRANCY-OP pag.131
BERTA pag.161	UMBERTA pag.163	LUCIA pag.173	MADDI pag.175	



BISSO/ANNA
for details see pag. 33



IESSE
for details see pag. 85



EMILIO/SERGIO
for details see pag. 22



NARDO/ROBY
for details see pag. 13

NEW
GREY COLOUR
AVAILABLE

FABIO
for details see pag.11

NEW
HALF LANTERN
FABIO



PROMO GARDEN 2024 - CLASSIC RANGE



DISMA/ROBY
for details see pag. 13

NEW
POST
EMILIO



MIKROLOT/MARY
for details see pag. 41



SICAR/G250
for details see pag. 25



NEW
SICAR IN
GREY COLOUR

NARDO/G250
for details see pag. 25



FABIO

HALF LANTERN



MADE IN ITALY



M20.000.E27

SMART PACK AVAILABLE

CCT SET			
6,5W 800 lm 2700 K	8,5W 920 lm 2700 K	11W 1200 lm 4000 K	11W 1200 lm 6500 K

More details at page 195



HALF LANTERN

AVAILABLE COLORS		E27 CCT LED VERSION	E27 FILAMENT LED VERSION	E27 VERSION							
<table border="1"> <tr> <th>RESIN BODY</th> <th>DIFFUSER</th> </tr> <tr> <td> BLACK (A) GREY (L) NEW COLOUR WHITE (W) </td> <td> CLEAR (X) OPAL (Y) </td> </tr> </table>	RESIN BODY	DIFFUSER	BLACK (A) GREY (L) NEW COLOUR WHITE (W)	CLEAR (X) OPAL (Y)	<table border="1"> <tr> <td>8,5W 920 lm 100-240V 50/60 Hz 2700K/4000K/6500K</td> <td> CCT SET = 75W INCANDESCENT </td> </tr> </table>	8,5W 920 lm 100-240V 50/60 Hz 2700K/4000K/6500K	CCT SET = 75W INCANDESCENT	<table border="1"> <tr> <td>6,5W 800 lm 100-240V 50/60 Hz 2700K</td> <td> CCT SET = 60W INCANDESCENT </td> </tr> </table>	6,5W 800 lm 100-240V 50/60 Hz 2700K	CCT SET = 60W INCANDESCENT	
RESIN BODY	DIFFUSER										
BLACK (A) GREY (L) NEW COLOUR WHITE (W)	CLEAR (X) OPAL (Y)										
8,5W 920 lm 100-240V 50/60 Hz 2700K/4000K/6500K	CCT SET = 75W INCANDESCENT										
6,5W 800 lm 100-240V 50/60 Hz 2700K	CCT SET = 60W INCANDESCENT										

FABIO

E27	M21.000.E27	SMART PACK
E27	M20.000.E27	SINGLE BOX
6,5W FILAMENT	M20.000.F1R	SINGLE BOX
8,5W CCT SET	M20.000.V1K	SINGLE BOX

Standard Master box: **18pcs**
Smart Pack Master box: **24pcs**

NEW

NEW
GREY COLOUR AVAILABLE

FABIO - AVAILABLE VERSIONS

FABIO E27 SINGLE BOX	FABIO E27 SMART PACK
<p>cbm: 0,16 Master box: 18 pcs</p>	<p>SAVE 35% VOLUME</p> <p>Save 35% volume ECO-friendly packaging Film wrapped items</p> <p>cbm: 0,14 Master box: 24 pcs</p>

10	REVIVAL
32	GARDEN CLASSIC
48	GARDEN CLASSIC
68	GARDEN CLASSIC
84	GARDEN CLASSIC
86	GARDEN CLASSIC
92	GARDEN CLASSIC
112	GARDEN CLASSIC
120	GARDEN CLASSIC
134	GARDEN CLASSIC
142	GARDEN CLASSIC
148	GARDEN CLASSIC
158	GARDEN CLASSIC
176	GARDEN CLASSIC
184	GARDEN CLASSIC
192	GARDEN CLASSIC
194	GARDEN CLASSIC

ROBY RANGE

SMALL SIZE



MADE IN ITALY

CCT SET	
6500K	6500K
4000K	4000K
2700K	2700K

6,5W 800 lm 2700 K	8,5W 920 lm 2700 K	11W 1200 lm 4000 K	11W 1200 lm 6500 K
--------------------------	--------------------------	--------------------------	--------------------------

More details at page 195



T20.240.E27

NEW
GREY COLOUR
AVAILABLE



SMALL SIZE

ROBY RANGE

AVAILABLE COLORS		E27 CCT LED VERSION	E27 FILAMENT LED VERSION	E27 VERSION
RESIN BODY BLACK (A) GREY (L) WHITE (W)		8,5W 920 lm 100-240V 50/60 Hz 2700K/4000K/6500K CCT SET = 75W INCANDESCENT	6,5W 800 lm 100-240V 50/60 Hz 2700K CCT SET = 60W INCANDESCENT	
DIFFUSER CLEAR (X) OPAL (Y)				

NARDO/ROBY

6,5W FILAMENT 2700K	T20.240.F1R
8,5W CCT SET	T20.240.V1K
E27	T20.240.E27

Master box: 18pcs

DISMA/ROBY

6,5W FILAMENT 2700K	T20.114.F1R
8,5W CCT SET	T20.114.V1K
E27	T20.114.E27

Master box: 18pcs

SICAR/ROBY

6,5W FILAMENT 2700K	T20.125.F1R
8,5W CCT SET	T20.125.V1K
E27	T20.125.E27

Master box: 18pcs

- 10 REVIVAL
- 32 GARDEN SMALL
- 48 GARDEN MEDIUM
- 68 GARDEN LARGE
- 84 HALF LANTERN
- 86 BOLLARD
- 92 BOLLARD
- 112 DOWNLIGHT
- 120 UP&DOWN
- 134 FLOODLIGHT
- 142 IN-GROUND
- 148 BRICKLIGHT
- 158 BULKHEAD
- 176 POST
- 184 SOLAR MODERN
- 192 SOLAR CLASSIC
- 194 LAMPS

ROBY RANGE
SMALL SIZE



MADE IN ITALY



CCT SET			
6,5W	8,5W	11W	
800 lm	920 lm	1200 lm	
2700 K	2700 K	4000 K	6500 K

More details at page 195

NEW
GREY COLOUR
AVAILABLE

T20.242.V1K



SMALL SIZE

ROBY RANGE

AVAILABLE COLORS	
RESIN BODY	DIFFUSER
BLACK (A) GREY (L) NEW COLOUR WHITE (W)	CLEAR (X) OPAL (Y)

E27 CCT LED VERSION	
	8,5W 920 lm 100-240V 50/60 Hz 2700K/4000K/6500K CCT SET = 75W INCANDESCENT

E27 CCT LED VERSION	
	6,5W 800 lm 100-240V 50/60 Hz 2700K CCT SET = 60W INCANDESCENT



NEW

GIAFFA/ROBY resin

IP55
6,5W 2700K FILAMENT T20.242.F1R
8,5W CCT SET T20.242.V1K

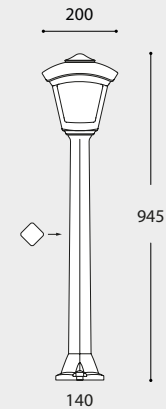

DANILO NARDO/ROBY 2L

IP55
6,5W 2700K FILAMENT T20.305.D20.F1R
8,5W CCT SET T20.305.D20.V1K

LED LAMP INCLUDED

NEW

DANILO NARDO/ROBY 3L

IP55
6,5W 2700K FILAMENT T20.305.D30.F1R
8,5W CCT SET T20.305.D30.V1K

LED LAMP INCLUDED

NEW

MADE IN ITALY

10	REVIVAL
32	GARDEN SMALL
48	GARDEN MEDIUM
68	GARDEN LARGE
84	HALF LANTERN
86	BOLLARD
92	BOLLARD
112	DOWNLIGHT
120	UP&DOWN
134	FLOODLIGHT
142	IN-GROUND
148	BRICKLIGHT
158	BULKHEAD
176	POST
184	SOLAR MODERN
192	SOLAR CLASSIC
194	LAMPS

DARIO RANGE

MEDIUM SIZE



MADE IN ITALY

AVAILABLE COLORS			
RESIN BODY		DIFFUSER	
BLACK (A)	GREY (L)	CLEAR (X)	OPAL (Y)

CCT SET			
6,5W 800 lm 2700 K	8,5W 920 lm 2700 K	11W 1200 lm 4000 K	11W 1200 lm 6500 K

More details at page 195



T24.116.V1K



NEW
GREY COLOUR
AVAILABLE



MEDIUM SIZE

DARIO RANGE

AVAILABLE COLORS		E27 CCT LED VERSION	E27 FILAMENT LED VERSION	E27 VERSION
		8,5W 920 lm 100-240V 50/60 Hz 2700K/4000K/6500K	6,5W 800 lm 100-240V 50/60 Hz 2700K	
BLACK (A)	GREY (L)	75W INCANDESCENT	60W INCANDESCENT	

NARDO/DARIO

IP55	6,5W 2700K FILAMENT	T24.240.F1R
	8,5W CCT SET	T24.240.V1K
	E27	T24.240.E27

Master box: **12pcs**

MIDIDISMA/DARIO

6,5W 2700K FILAMENT	T24.116.F1R
8,5W CCT SET	T24.116.V1K
E27	T24.116.E27

NEW BASE MIDIDISMA

Master box: **12pcs**

SICAR/DARIO

6,5W 2700K FILAMENT	T24.125.F1R
8,5W CCT SET	T24.125.V1K
E27	T24.125.E27

Master box: **12pcs**

- 10 REVIVAL
- 32 GARDEN SMALL
- 48 GARDEN MEDIUM
- 68 GARDEN LARGE
- 84 HALF LANTERN
- 86 BOLLARD
- 92 BOLLARD
- 112 DOWNLIGHT
- 120 UP&DOWN
- 134 FLOODLIGHT
- 142 IN-GROUND
- 148 BRICKLIGHT
- 158 BULKHEAD
- 176 POST
- 184 SOLAR MODERN
- 192 SOLAR CLASSIC
- 194 LAMPS

"METAL POST COVERED BY RESIN"

fumaTech
FUMAGALLI POLES TECHNOLOGY

ANTI RUST LIFETIME GUARANTEE
NO PAINTING REQUIRED
MADE IN ITALY

ANTI CORROSION **UV-RAYS STABILIZED** **NO MAINTENANCE** **DOUBLE INSULATION** **NOT AFFECTED BY CHEMICAL FERTILIZES**

GIAFFA/DARIO resin

	6,5W 2700K FILAMENT	T24.242.F1R
	8,5W CCT SET	T24.242.V1K

LED LAMP INCLUDED

NEW

DANILO/DARIO

	6,5W 2700K FILAMENT	T24.305.F1R
	8,5W CCT SET	T24.305.V1K

LED LAMP INCLUDED

NEW

DINO/DARIO

	6,5W 2700K FILAMENT	T24.306.F1R
	8,5W CCT SET	T24.306.V1K

LED LAMP INCLUDED

NEW

DINO NARDO/DARIO 2L

	6,5W 2700K FILAMENT	T24.306.D20.F1R
	8,5W CCT SET	T24.306.D20.V1K

LED LAMP INCLUDED

NEW

DINO NARDO/DARIO 3L

	6,5W 2700K FILAMENT	T24.306.D30.F1R
	8,5W CCT SET	T24.306.D30.V1K

LED LAMP INCLUDED

NEW

EMILIO NARDO/DARIO 2L

	6,5W 2700K FILAMENT	T24.307.D20.F1R
	8,5W CCT SET	T24.307.D20.V1K

LED LAMP INCLUDED

NEW

EMILIO NARDO/DARIO 3L

	6,5W 2700K FILAMENT	T24.307.D30.F1R
	8,5W CCT SET	T24.307.D30.V1K

LED LAMP INCLUDED

NEW

10	REVIVAL
32	GARDEN SMALL
48	GARDEN MEDIUM
68	GARDEN LARGE
84	HALF LANTERN
86	BOLLARD
92	BOLLARD
112	DOWNLIGHT
120	UP&DOWN
134	FLOODLIGHT
142	IN-GROUND
148	BRICKLIGHT
158	BULKHEAD
176	POST
184	SOLAR MODERN
192	SOLAR CLASSIC
194	LAMPS

SERGIO RANGE

LARGE SIZE



MADE IN ITALY



HIGH POWER LED VERSION

T33.117.Q1K

NEW
GREY COLOUR AVAILABLE

E27 HIGH POWER LED

INDOOR & OUTDOOR USE

+80°C -30°C 90% HUMIDITY

VOLTAGE SURGE RESISTANT

15W (1690 lm)
30W (3620 lm)
50W (6550 lm)

More details at page 196



LARGE SIZE

SERGIO RANGE

AVAILABLE COLORS

RESIN BODY			DIFFUSER	
BLACK (A)	GREY (L)	WHITE (W)	CLEAR (X)	OPAL (Y)

E27 HIGH POWER LED VERSION

15W	30W
1690 lm	3620 lm
100-240V 50/60 Hz	100-240V 50/60 Hz
4000K/3000K	4000K/3000K
= SERGIO 100W INCANDESCENT	= SERGIO 70W HQI-SON

IOLE/SERGIO

15W LED	CCT SET	T33.243.R1K
30W LED	CCT SET	T33.243.Q1K

HIGH POWER LED VERSION

available from JULY 2024

MAXIDISMA/SERGIO

15W LED	CCT SET	T33.117.R1K
30W LED	CCT SET	T33.117.Q1K

HIGH POWER LED VERSION

SICAR/SERGIO

15W LED	CCT SET	T33.126.R1K
30W LED	CCT SET	T33.126.Q1K



HIGH POWER LED VERSION

- 10 REVIVAL
- 32 GARDEN SMALL
- 48 GARDEN MEDIUM
- 68 GARDEN LARGE
- 84 HALF LANTERN
- 86 BOLLARD
- 92 BOLLARD
- 112 DOWNLIGHT
- 120 UP&DOWN
- 134 FLOODLIGHT
- 142 IN-GROUND
- 148 BRICKLIGHT
- 158 BULKHEAD
- 176 POST
- 184 SOLAR MODERN
- 192 SOLAR CLASSIC
- 194 LAMPS

SERGIO RANGE

LARGE SIZE

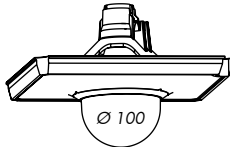

E27 HIGH POWER LED VERSION					
LAMP	POWER	LUMINOUS FLUX UP TO	VOLTAGE RANGE	CCT SETTABLE	COMPARISON
	15W	1690 lm	100-240V 50/60 Hz	4000K/3000K	= SERGIO  100W INCANDESCENT
	30W	3620 lm	100-240V 50/60 Hz	4000K/3000K	= SERGIO  70W HQI-SON



LARGE SIZE

SERGIO RANGE

"METAL POST COVERED BY RESIN"

STEEL
RESIN
EXPANSE

FumaTech
FUMAGALLI POLES TECHNOLOGY

ANTI RUST
LIFETIME GUARANTEE
NO PAINTING REQUIRED
MADE IN ITALY

ANTI CORROSION
UV-RAYS STABILIZED
NO MAINTENANCE
DOUBLE INSULATION
NOT AFFECTED BY CHEMICAL FERTILIZERS

VANNI 2500/SERGIO

30W LED CCT SET T33.310.Q1K

IP55

HIGH POWER LED VERSION



330

2840

Ø 265

available from JULY 2024

VANNI 2500 IOLE/SERGIO 2L

30W LED CCT SET T33.310.E20.Q1K

IP55

HIGH POWER LED VERSION



800

2940

Ø 265

2

available from JULY 2024

DANILO/SERGIO

15W LED CCT SET T33.305.R1K

30W LED CCT SET T33.305.Q1K

IP55

HIGH POWER LED VERSION



330

1870

Ø 245

Master box: 2pcs

NEW

DINO/SERGIO

15W LED CCT SET T33.306.R1K

30W LED CCT SET T33.306.Q1K

IP55

HIGH POWER LED VERSION



330

2120

Ø 245

Master box: 2pcs

NEW

EMILIO/SERGIO

15W LED CCT SET T33.307.R1K

30W LED CCT SET T33.307.Q1K

IP55

HIGH POWER LED VERSION

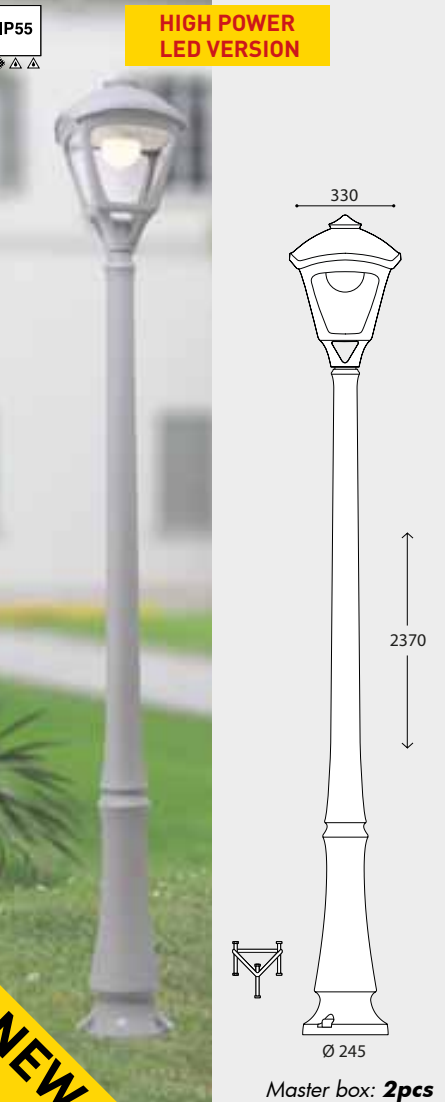

330

2370

Ø 245

Master box: 2pcs

NEW

- 10 REVIVAL
- 32 GARDEN SMALL
- 48 GARDEN MEDIUM
- 68 GARDEN LARGE
- 84 HALF LANTERN
- 86 BOLLARD
- 92 BOLLARD
- 112 DOWNLIGHT
- 120 UP&DOWN
- 134 FLOODLIGHT
- 142 IN-GROUND
- 148 BRICKLIGHT
- 158 BULKHEAD
- 176 POST
- 184 SOLAR MODERN
- 192 SOLAR CLASSIC
- 194 LAMPS

REVIVAL

GLOBE 250 RANGE

MODERN



MADE IN ITALY



G26.240.E27

NEW
GREY COLOUR
AVAILABLE

CCT SET			
6500K	4000K	2700K	2700K
6,5W 800 lm	8,5W 920 lm	11W 1200 lm	
2700 K	2700 K	4000 K	6500 K

More details at page 195



SMALL SIZE **GLOBE 250 MODERN**

AVAILABLE COLORS			E27 CCT LED VERSION	E27 FILAMENT LED VERSION	E27 VERSION
RESIN BODY BLACK (A) NEW COLOUR GREY (L) WHITE (W)			 8,5W 920 lm 100-240V 50/60 Hz 2700K/4000K/6500K CCT SET = 75W INCANDESCENT	 6,5W 800 lm 100-240V 50/60 Hz 2700K = 60W INCANDESCENT	
DIFFUSER CLEAR (X) OPAL (Y) SMOKED (Z)					
(Color swatches for diffusers)					

NARDO/G250

IP55	6,5W 2700K FILAMENT	G26.240.F1R
	8,5W CCT SET	G26.240.V1K
	E27	G26.240.E27

Master box: **36pcs**

DISMA/G250		SICAR/G250	
6,5W 2700K FILAMENT	G26.114.F1R	6,5W 2700K FILAMENT	G26.125.F1R
8,5W CCT SET	G26.114.V1K	8,5W CCT SET	G26.125.V1K
E27	G26.114.E27	E27	G26.125.E27

DISMA/G250

Master box: **36pcs**

SICAR/G250

Master box: **36pcs**

MADE IN ITALY

GARDEN CLASSIC

- 10 REVIVAL
- 32 GARDEN SMALL
- 48 GARDEN MEDIUM
- 68 GARDEN LARGE
- 84 HALF LANTERN
- 86 BOLLARD
- 92 BOLLARD
- 112 DOWNLIGHT
- 120 UP&DOWN
- 134 FLOODLIGHT
- 142 IN-GROUND
- 148 BRICKLIGHT
- 158 BULKHEAD
- 176 POST

GARDEN MODERN

- 184 SOLAR MODERN
- 192 SOLAR CLASSIC
- 194 LAMPS

GLOBE 250 MODERN

SMALL SIZE



AVAILABLE COLORS

RESIN BODY

NEW COLOUR

BLACK (A) GREY (L) WHITE (W)

DIFFUSER

CLEAR (X) OPAL (Y) SMOKED (Z)

E27 CCT LED VERSION

8,5W
920 lm
100-240V
50/60 Hz
2700K/4000K/6500K

CCT SET

75W INCANDESCENT

E27 FILAMENT LED VERSION

6,5W
800 lm
100-240V
50/60 Hz
2700K

60W INCANDESCENT

GIAFFA/G250 resin

IP55

6,5W 2700K FILAMENT G26.242.F1R
8,5W CCT SET G26.242.V1K

Ø250
1000
140

Master box: 2pcs

NEW

DANILO/G250

IP55

6,5W 2700K FILAMENT G26.305.F1R
8,5W CCT SET G26.305.V1K

LED LAMP INCLUDED

Ø250
1740
Ø245

Master box: 2pcs

NEW

DINO/G250

IP55

6,5W 2700K FILAMENT G26.306.F1R
8,5W CCT SET G26.306.V1K

LED LAMP INCLUDED

Ø250
1980
Ø245

Master box: 2pcs

NEW



SMALL SIZE

GLOBE 250 MODERN

"METAL POST COVERED BY RESIN"

STEEL
RESIN
EXPANSE

ANTI RUST LIFETIME GUARANTEE NO PAINTING REQUIRED
MADE IN ITALY

ANTI CORROSION UV-RAYS STABILIZED NO MAINTENANCE DOUBLE INSULATION NOT AFFECTED BY CHEMICAL FERTILIZERS

FumaTech FUMAGALLI POLES TECHNOLOGY

DINO NARDO/G250 2L

IP55

6,5W 2700K FILAMENT G26.306.D20.F1R
8,5W CCT SET G26.306.D20.V1K

LED LAMP INCLUDED

640
1980
Ø250
Ø245

Master box: 2pcs

NEW

DINO NARDO/G250 3L

IP55

6,5W 2700K FILAMENT G26.306.D30.F1R
8,5W CCT SET G26.306.D30.V1K

LED LAMP INCLUDED

590
1980
Ø250
Ø245

Master box: 2pcs

NEW

- 10 REVIVAL
- 32 GARDEN SMALL
- 48 GARDEN MEDIUM
- 68 GARDEN LARGE
- 84 HALF LANTERN
- 86 BOLLARD
- 92 BOLLARD
- 112 DOWNLIGHT
- 120 UP&DOWN
- 134 FLOODLIGHT
- 142 IN-GROUND
- 148 BRICKLIGHT
- 158 BULKHEAD
- 176 POST
- 184 SOLAR MODERN
- 192 SOLAR CLASSIC
- 194 LAMPS

REVIVAL

GLOBE 300 RANGE

MODERN



MADE IN ITALY

CCT SET	
6,5W 800 lm 2700 K	8,5W 920 lm 2700 K
	11W 1200 lm 4000 K
	11W 1200 lm 6500 K

More details at page 195



NEW
GREY COLOUR AVAILABLE

G31.116.E27



MEDIUM SIZE GLOBE 300 MODERN

AVAILABLE COLORS					
RESIN BODY			DIFFUSER		
BLACK (A)	GREY (L)	WHITE (W)	CLEAR (X)	OPAL (Y)	SMOKED (Z)

E27 CCT LED VERSION
11W 1200 lm 100-240V 50/60 Hz 2700K/4000K/6500K
CCT SET = 75W INCANDESCENT

E27 FILAMENT LED VERSION
6,5W 800 lm 100-240V 50/60 Hz 2700K
CCT SET = 60W INCANDESCENT

E27 VERSION



NEW

NARDO/G300		
IP55	6,5W FILAMENT 2700K	G31.240.F1R
	11W CCT SET	G31.240.T1K
	E27	G31.240.E27

Master box: 24pcs

MIDIDISMA/G300		
6,5W FILAMENT 2700K	G31.116.F1R	
11W CCT SET	G31.116.T1K	
E27	G31.116.E27	

NEW BASE MIDIDISMA

Master box: 24pcs

NEW

SICAR/G300		
6,5W FILAMENT 2700K	G31.125.F1R	
11W CCT SET	G31.125.T1K	
E27	G31.125.E27	

Master box: 24pcs

NEW

MADE IN ITALY

- 10 REVIVAL
- 32 GARDEN SMALL
- 48 GARDEN MEDIUM
- 68 GARDEN LARGE
- 84 HALF LANTERN
- 86 BOLLARD
- 92 BOLLARD
- 112 DOWNLIGHT
- 120 UP&DOWN
- 134 FLOODLIGHT
- 142 IN-GROUND
- 148 BRICKLIGHT
- 158 BULKHEAD
- 176 POST
- 184 SOLAR MODERN
- 192 SOLAR CLASSIC
- 194 LAMPS

GLOBE 300 MODERN

MEDIUM SIZE



AVAILABLE COLORS

RESIN BODY			DIFFUSER		
BLACK (A)	GREY (L)	WHITE (W)	CLEAR (X)	OPAL (Y)	SMOKED (Z)

E27 CCT LED VERSION

	8,5W
	920 lm
	100-240V
	50/60 Hz
	2700K/4000K/6500K
CCT SET	75W INCANDESCENT

E27 FILAMENT LED VERSION

	6,5W
	800 lm
	100-240V
	50/60 Hz
	2700K
CCT SET	60W INCANDESCENT

GIAFFA/G300 resin

IP55	6,5W 2700K FILAMENT	G31.242.F1R
	8,5W CCT SET	G31.242.T1K

Master box: **2pcs**

DANILO/G300

6,5W 2700K FILAMENT	G31.305.F1R
11W CCT SET	G31.305.T1K

IP55

LED LAMP INCLUDED

Master box: **2pcs**

DINO/G300

6,5W 2700K FILAMENT	G31.306.F1R
11W CCT SET	G31.306.T1K

IP55

LED LAMP INCLUDED

Master box: **2pcs**

EMILIO/G300

6,5W 2700K FILAMENT	G31.307.F1R
11W CCT SET	G31.307.T1K

IP55

LED LAMP INCLUDED

Master box: **2pcs**



MEDIUM SIZE

GLOBE 300 MODERN

"METAL POST COVERED BY RESIN"

fumaTech FUMAGALLI POLES TECHNOLOGY

ANTI RUST LIFETIME GUARANTEE NO PAINTING REQUIRED **MADE IN ITALY**

ANTI CORROSION **UV-RAYS STABILIZED** **NO MAINTENANCE** **DOUBLE INSULATION** **NOT AFFECTED BY CHEMICAL FERTILIZERS**

EMILIO NARDO/G300 2L

IP55	6,5W 2700K FILAMENT	G31.307.D20.F1R
	11W CCT SET	G31.307.D20.T1K

LED LAMP INCLUDED

Master box: **2pcs**

EMILIO NARDO/G300 3L

IP55	6,5W 2700K FILAMENT	G31.307.D30.F1R
	11W CCT SET	G31.307.D30.T1K

LED LAMP INCLUDED

Master box: **2pcs**

- 10 REVIVAL
- 32 GARDEN SMALL
- 48 GARDEN MEDIUM
- 68 GARDEN LARGE
- 84 HALF LANTERN
- 86 BOLLARD
- 92 BOLLARD
- 112 DOWNLIGHT
- 120 UP&DOWN
- 134 FLOODLIGHT
- 142 IN-GROUND
- 148 BRICKLIGHT
- 158 BULKHEAD
- 176 POST
- 184 SOLAR MODERN
- 192 SOLAR CLASSIC
- 194 LAMPS

ANNA RANGE

SMALL SIZE



MADE IN ITALY

E22.110.V1K

CCT SET			
6,5W 800 lm 2700 K	8,5W 920 lm 2700 K	11W 1200 lm 4000 K	6500 K

More details at page 195



SMALL SIZE

ANNA RANGE

AVAILABLE COLORS				E27 CCT LED VERSION	E27 FILAMENT LED VERSION	E27 VERSION
RESIN BODY		DIFFUSER				
				8,5W 920 lm 100-240V 50/60 Hz 2700K/4000K/6500K CCT SET = 60W INCANDESCENT	6,5W 800 lm 100-240V 50/60 Hz 2700K = 60W INCANDESCENT	
BLACK (A)	WHITE (W)	CLEAR (X)	OPAL (Y)			

BISSO/ANNA

IP55	6,5W FILAMENT 2700K	E22.131.F1R
	8,5W CCT SET	E22.131.V1K
	E27	E22.131.E27

Master box: 18pcs

MIKROLOT/ANNA		SICHEM/ANNA	
6,5W FILAMENT 2700K	E22.110.F1R	6,5W FILAMENT 2700K	E22.120.F1R
8,5W CCT SET	E22.110.V1K	8,5W CCT SET	E22.120.V1K
E27	E22.110.E27	E27	E22.120.E27

Master box: 18pcs

Master box: 18pcs

10	REVIVAL
32	GARDEN SMALL
48	GARDEN MEDIUM
68	GARDEN LARGE
84	HALF LANTERN
86	BOLLARD
92	BOLLARD
112	DOWNLIGHT
120	UP&DOWN
134	FLOODLIGHT
142	IN-GROUND
148	BRICKLIGHT
158	BULKHEAD
176	POST
184	SOLAR MODERN
192	SOLAR CLASSIC
194	LAMPS

ANNA RANGE

SMALL SIZE



AVAILABLE COLORS			
RESIN BODY		DIFFUSER	
BLACK (A)	WHITE (W)	CLEAR (X)	OPAL (Y)

E27 CCT LED VERSION	
	8,5W 920 lm 100-240V 50/60 Hz 2700K/4000K/6500K CCT SET 60W INCANDESCENT

E27 FILAMENT LED VERSION	
	6,5W 800 lm 100-240V 50/60 Hz 2700K 60W INCANDESCENT

MIZAR/ANNA (resin)

IP55

6,5W FILAMENT 2700K	E22.151.F1R
8,5W CCT SET	E22.151.V1K

LED LAMP INCLUDED

ALOE'.R/ANNA (resin)

IP55

6,5W FILAMENT 2700K	E22.163.F1R
8,5W CCT SET	E22.163.V1K

LED LAMP INCLUDED

ARTU'/ANNA

IP55

6,5W FILAMENT 2700K	E22.158.F1R
8,5W CCT SET	E22.158.V1K

LED LAMP INCLUDED



SMALL SIZE

ANNA RANGE

"METAL POST COVERED BY RESIN"

ANTI RUST LIFETIME GUARANTEE NO PAINTING REQUIRED MADE IN ITALY

ANTI CORROSION UV-RAYS STABILIZED NO MAINTENANCE DOUBLE INSULATION NOT AFFECTED BY CHEMICAL FERTILIZERS

GIGI BISSO/ANNA 2L

IP55

6,5W FILAMENT 2700K	E22.156.S20.F1R
8,5W CCT SET	E22.156.S20.V1K

LED LAMP INCLUDED

GIGI BISSO/ANNA 3L

IP55

6,5W FILAMENT 2700K	E22.156.S30.F1R
8,5W CCT SET	E22.156.S30.V1K

LED LAMP INCLUDED

- 10 REVIVAL
- 32 GARDEN SMALL
- 48 GARDEN MEDIUM
- 68 GARDEN LARGE
- 84 HALF LANTERN
- 86 BOLLARD
- 92 BOLLARD
- 112 DOWNLIGHT
- 120 UP&DOWN
- 134 FLOODLIGHT
- 142 IN-GROUND
- 148 BRICKLIGHT
- 158 BULKHEAD
- 176 POST
- 184 SOLAR MODERN
- 192 SOLAR CLASSIC
- 194 LAMPS

SABA RANGE

SMALL SIZE



MADE IN ITALY



K22.131.F1R

CCT SET		
6,5W 800 lm 2700 K	8,5W 920 lm 2700 K	11W 1200 lm 4000 K 6500 K

More details at page 195



SMALL SIZE

SABA RANGE

AVAILABLE COLORS			
RESIN BODY		DIFFUSER	
BLACK (A)	WHITE (W)	CLEAR (X)	OPAL (Y)

E27 CCT LED VERSION	
	8,5W 920 lm 100-240V 50/60 Hz 2700K/4000K/6500K
	60W INCANDESCENT

E27 FILAMENT LED VERSION	
	6,5W 800 lm 100-240V 50/60 Hz 2700K
	60W INCANDESCENT

E27 VERSION	

BISSO/SABA		
IP55	6,5W 2700K FILAMENT	K22.131.F1R
	8,5W CCT SET	K22.131.V1K
	E27	K22.131.E27

Master box: 18pcs

MIKROLOT/SABA		
IP55	6,5W 2700K FILAMENT	K22.110.F1R
	8,5W CCT SET	K22.110.V1K
	E27	K22.110.E27

Master box: 18pcs

SICHEM/SABA		
IP55	6,5W 2700K FILAMENT	K22.120.F1R
	8,5W CCT SET	K22.120.V1K
	E27	K22.120.E27

Master box: 18pcs

10	REVIVAL
32	GARDEN SMALL
48	GARDEN MEDIUM
68	GARDEN LARGE
84	HALF LANTERN
86	BOLLARD
92	BOLLARD
112	DOWNLIGHT
120	UP&DOWN
134	FLOODLIGHT
142	IN-GROUND
148	BRICKLIGHT
158	BULKHEAD
176	POST
184	SOLAR MODERN
192	SOLAR CLASSIC
194	LAMPS

SABA RANGE

SMALL SIZE



AVAILABLE COLORS

RESIN BODY		DIFFUSER	
BLACK (A)	WHITE (W)	CLEAR (X)	OPAL (Y)

E27 CCT LED VERSION

	8,5W 920 lm 100-240V 50/60 Hz 2700K/4000K/6500K CCT SET 60W INCANDESCENT
--	--

E27 FILAMENT LED VERSION

	6,5W 800 lm 100-240V 50/60 Hz 2700K 60W INCANDESCENT
--	---

MIZAR/SABA (resin)

	6,5W FILAMENT 2700K K22.151.F1R 8,5W CCT SET K22.151.V1K
--	---

LED LAMP INCLUDED

ALOE'.R/SABA (resin)

	6,5W FILAMENT 2700K K22.163.F1R 8,5W CCT SET K22.163.V1K
--	---

LED LAMP INCLUDED

ARTU'/SABA

	6,5W FILAMENT 2700K K22.158.F1R 8,5W CCT SET K22.158.V1K
--	---

LED LAMP INCLUDED



SMALL SIZE

SABA RANGE

"METAL POST COVERED BY RESIN"

STEEL, RESIN, EXPANSE

fumaTech FUMAGALLI POLES TECHNOLOGY

ANTI RUST LIFETIME GUARANTEE NO PAINTING REQUIRED MADE IN ITALY

ANTI CORROSION, UV-RAYS STABILIZED, NO MAINTENANCE, DOUBLE INSULATION, NOT AFFECTED BY CHEMICAL FERTILIZERS

GIGI BISSO/SABA 2L

	6,5W FILAMENT 2700K K22.156.S20.F1R 8,5W CCT SET K22.156.S20.V1K
--	---

LED LAMP INCLUDED

IP55

GIGI BISSO/SABA 3L

	6,5W FILAMENT 2700K K22.156.S30.F1R 8,5W CCT SET K22.156.S30.V1K
--	---

LED LAMP INCLUDED

IP55

- 10 REVIVAL
- 32 GARDEN SMALL
- 48 GARDEN MEDIUM
- 68 GARDEN LARGE
- 84 HALF LANTERN
- 86 BOLLARD
- 92 BOLLARD
- 112 DOWNLIGHT
- 120 UP&DOWN
- 134 FLOODLIGHT
- 142 IN-GROUND
- 148 BRICKLIGHT
- 158 BULKHEAD
- 176 POST
- 184 SOLAR MODERN
- 192 SOLAR CLASSIC
- 194 LAMPS

MARY RANGE

SMALL SIZE



MADE IN ITALY



Q18.110.F1R

CCT SET		
6,5W 800 lm 2700 K	8,5W 920 lm 2700 K	11W 1200 lm 4000 K 6500 K

More details at page 195



SMALL SIZE

MARY RANGE

AVAILABLE COLORS		E27 CCT LED VERSION	E27 FILAMENT LED VERSION	E27 VERSION
RESIN BODY	DIFFUSER	8,5W 920 lm 100-240V 50/60 Hz 2700K/4000K/6500K	6,5W 800 lm 100-240V 50/60 Hz 2700K	
BLACK (A)	WHITE (W)	CLEAR (X)	OPAL (Y)	
		60W INCANDESCENT	60W INCANDESCENT	

BISSO/MARY



6,5W FILAMENT 2700K	Q18.131.F1R
8,5W CCT SET	Q18.131.V1K
E27	Q18.131.E27

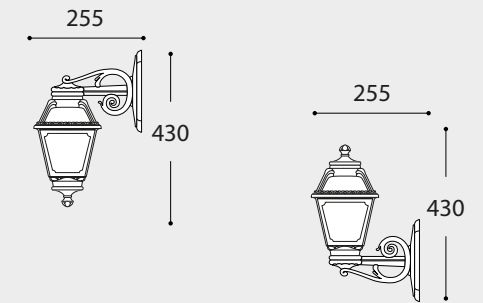

Master box: 18pcs

MIKROLOT/MARY

6,5W FILAMENT 2700K	Q18.110.F1R
8,5W CCT SET	Q18.110.V1K
E27	Q18.110.E27



Master box: 18pcs

SICHEM/MARY

6,5W FILAMENT 2700K	Q18.120.F1R
8,5W CCT SET	Q18.120.V1K
E27	Q18.120.E27

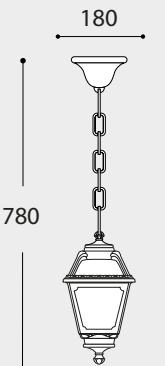

Master box: 18pcs

10	REVIVAL
32	GARDEN SMALL
48	GARDEN MEDIUM
68	GARDEN LARGE
84	HALF LANTERN
86	BOLLARD
92	BOLLARD
112	DOWNLIGHT
120	UP&DOWN
134	FLOODLIGHT
142	IN-GROUND
148	BRICKLIGHT
158	BULKHEAD
176	POST
184	SOLAR MODERN
192	SOLAR CLASSIC
194	LAMPS

MARY RANGE

SMALL SIZE



AVAILABLE COLORS

RESIN BODY		DIFFUSER	
BLACK (A)	WHITE (W)	CLEAR (X)	OPAL (Y)

E27 CCT LED VERSION

8,5W
920 lm
100-240V
50/60 Hz
2700K/4000K/6500K
60W INCANDESCENT

E27 FILAMENT LED VERSION

6,5W
800 lm
100-240V
50/60 Hz
2700K
60W INCANDESCENT

MIZAR/MARY (resin)



6,5W FILAMENT	2700K	Q18.151.F1R
8,5W CCT SET		Q18.151.V1K

ARTU'BISSO/MARY 2L



6,5W FILAMENT	2700K	Q18.158.S20.F1R
8,5W CCT SET		Q18.158.S20.V1K

ARTU'BISSO/MARY 3L

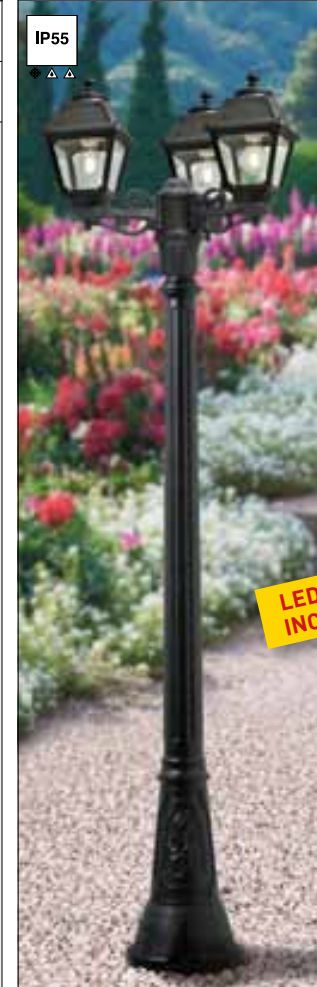

6,5W FILAMENT	2700K	Q18.158.S30.F1R
8,5W CCT SET		Q18.158.S30.V1K



SMALL SIZE

MARY RANGE

"METAL POST COVERED BY RESIN"

fumaTech FUMAGALLI POLES TECHNOLOGY

LIFETIME GUARANTEE ANTI RUST NO PAINTING REQUIRED

MADE IN ITALY

ANTI CORROSION **UV-RAYS STABILIZED** **NO MAINTENANCE** **DOUBLE INSULATION** **NOT AFFECTED BY CHEMICAL FERTILIZERS**

GIGI BISSO/MARY 2L

6,5W FILAMENT	2700K	Q18.156.S20.F1R
8,5W CCT SET		Q18.156.S20.V1K

GIGI BISSO/MARY 3L

6,5W FILAMENT	2700K	Q18.156.S30.F1R
8,5W CCT SET		Q18.156.S30.V1K

- 10 REVIVAL
- 32 GARDEN SMALL
- 48 GARDEN MEDIUM
- 68 GARDEN LARGE
- 84 HALF LANTERN
- 86 BOLLARD
- 92 BOLLARD
- 112 DOWNLIGHT
- 120 UP&DOWN
- 134 FLOODLIGHT
- 142 IN-GROUND
- 148 BRICKLIGHT
- 158 BULKHEAD
- 176 POST
- 184 SOLAR MODERN
- 192 SOLAR CLASSIC
- 194 LAMPS

GARDEN CLASSIC

GLOBE 250 CLASSIC

SMALL SIZE



MADE IN ITALY

CCT SET	
6,5W 800 lm 2700 K	8,5W 920 lm 2700 K
11W 1200 lm 4000 K	11W 1200 lm 6500 K

More details at page 195



G25.131.F1R



SMALL SIZE GLOBE 250 CLASSIC

AVAILABLE COLORS					E27 CCT LED VERSION		E27 FILAMENT LED VERSION		E27 VERSION
RESIN BODY		DIFFUSER							
BLACK (A)	WHITE (W)	CLEAR (X)	OPAL (Y)	SMOKED (Z)	8,5W 920 lm 100-240V 50/60 Hz 2700K/4000K/6500K		6,5W 800 lm 100-240V 50/60 Hz 2700K		
					CCT SET = 60W INCANDESCENT		CCT SET = 60W INCANDESCENT		

BISSO/G250



6,5W 2700K FILAMENT	G25.131.F1R
8,5W CCT SET	G25.131.V1K
E27	G25.131.E27

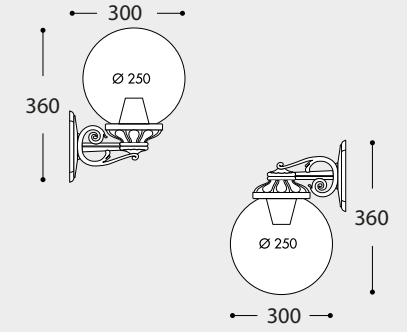

Master box: 36pcs

MIKROLOT/G250

6,5W 2700K FILAMENT	G25.110.F1R
8,5W CCT SET	G25.110.V1K
E27	G25.110.E27

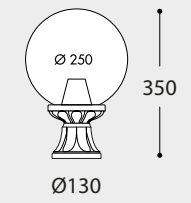

Master box: 36pcs

SICHEM/G250

6,5W 2700K FILAMENT	G25.120.F1R
8,5W CCT SET	G25.120.V1K
E27	G25.120.E27

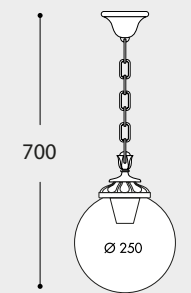

Master box: 36pcs

MADE IN ITALY

- 10 REVIVAL
- 32 GARDEN SMALL
- 48 GARDEN MEDIUM
- 68 GARDEN LARGE
- 84 HALF LANTERN
- 86 BOLLARD
- 92 BOLLARD
- 112 DOWNLIGHT
- 120 UP&DOWN
- 134 FLOODLIGHT
- 142 IN-GROUND
- 148 BRICKLIGHT
- 158 BULKHEAD
- 176 POST
- 184 SOLAR MODERN
- 192 SOLAR CLASSIC
- 194 LAMPS

GLOBE 250 CLASSIC SMALL SIZE



AVAILABLE COLORS				
RESIN BODY		DIFFUSER		
BLACK (A)	WHITE (W)	CLEAR (X)	OPAL (Y)	SMOKED (Z)

E27 CCT LED VERSION	
	8,5W 920 lm 100-240V 50/60 Hz 2700K/4000K/6500K
	60W INCANDESCENT

E27 FILAMENT LED VERSION	
	6,5W 800 lm 100-240V 50/60 Hz 2700K
	60W INCANDESCENT



MIZAR/G250 (resin)

6,5W FILAMENT 2700K	G25.151.F1R
8,5W CCT SET	G25.151.V1K

Master box: **2pcs**



ALOE'.R/G250 (resin)

6,5W FILAMENT 2700K	G25.163.F1R
8,5W CCT SET	G25.163.V1K

Master box: **2pcs**



ARTU'/G250

6,5W FILAMENT 2700K	G25.158.F1R
8,5W CCT SET	G25.158.V1K

Master box: **2pcs**



SMALL SIZE GLOBE 250 CLASSIC

"METAL POST COVERED BY RESIN"

fumaTech FUMAGALLI POLES TECHNOLOGY

ANTI RUST **LIFETIME GUARANTEE** NO PAINTING REQUIRED **MADE IN ITALY**

ANTI CORROSION UV-RAYS STABILIZED NO MAINTENANCE DOUBLE INSULATION NOT AFFECTED BY CHEMICAL FERTILIZERS

GIGI BISSO/G250 2L

6,5W FILAMENT 2700K	G25.156.S20.F1R
8,5W CCT SET	G25.156.S20.V1K

Master box: **2pcs**

GIGI BISSO/G250 3L

6,5W FILAMENT 2700K	G25.156.S30.F1R
8,5W CCT SET	G25.156.S30.V1K

Master box: **2pcs**

10	REVIVAL
32	GARDEN SMALL
48	GARDEN MEDIUM
68	GARDEN LARGE
84	HALF LANTERN
86	BOLLARD
92	BOLLARD
112	DOWNLIGHT
120	UP&DOWN
134	FLOODLIGHT
142	IN-GROUND
148	BRICKLIGHT
158	BULKHEAD
176	POST
184	SOLAR MODERN
192	SOLAR CLASSIC
194	LAMPS

RUT RANGE

MEDIUM SIZE



MADE IN ITALY



E26.157.S30.F1R

CCT SET			
6,5W 800 lm	8,5W 920 lm	11W 1200 lm	
2700 K	2700 K	4000 K	6500 K

More details at page 195



AVAILABLE COLORS				E27 CCT LED VERSION		E27 FILAMENT LED VERSION		E27 VERSION	
RESIN BODY		DIFFUSER							
				11W 1200 lm 100-240V 50/60 Hz 2700K/4000K/6500K		6,5W 800 lm 100-240V 50/60 Hz 2700K			
BLACK (A)	WHITE (W)	CLEAR (X)	OPAL (Y)	= 75W INCANDESCENT		= 60W INCANDESCENT			

BISSO/RUT

6,5W 2700K FILAMENT	E26.131.F1R
11W CCT SET	E26.131.T1K
E27	E26.131.E27

Master box: **12pcs**

MINILOT/RUT		SICHEM/RUT	
6,5W 2700K FILAMENT	E26.111.F1R	6,5W 2700K FILAMENT	E26.120.F1R
11W CCT SET	E26.111.T1K	11W CCT SET	E26.120.T1K
E27	E26.111.E27	E27	E26.120.E27

Master box: **12pcs**

Master box: **12pcs**

GARDEN CLASSIC

- 10 REVIVAL
- 32 GARDEN SMALL
- 48 GARDEN MEDIUM
- 68 GARDEN LARGE
- 84 HALF LANTERN
- 86 BOLLARD

GARDEN MODERN

- 92 BOLLARD
- 112 DOWNLIGHT
- 120 UP&DOWN
- 134 FLOODLIGHT
- 142 IN-GROUND
- 148 BRICKLIGHT
- 158 BULKHEAD
- 176 POST

SOLAR

- 184 SOLAR MODERN
- 192 SOLAR CLASSIC
- 194 LAMPS

RUT RANGE

MEDIUM SIZE



AVAILABLE COLORS			
RESIN BODY		DIFFUSER	
BLACK (A)	WHITE (W)	CLEAR (X)	OPAL (Y)

E27 CCT LED VERSION		E27 FILAMENT LED VERSION	
8,5W	920 lm	11W	1200 lm
100-240V	50/60 Hz	100-240V	50/60 Hz
2700K/4000K/6500K		2700K/4000K/6500K	
60W INCANDESCENT	CCT SET	75W INCANDESCENT	60W INCANDESCENT

E27 CCT LED VERSION		E27 FILAMENT LED VERSION	
6,5W	800 lm	6,5W	800 lm
100-240V	50/60 Hz	100-240V	50/60 Hz
2700K/4000K/6500K		2700K	
60W INCANDESCENT	CCT SET	60W INCANDESCENT	60W INCANDESCENT



MIZAR/RUT (resin)

6,5W FILAMENT 2700K	E26.151.F1R
8,5W CCT SET	E26.151.V1K
11W CCT SET	E26.151.T1K

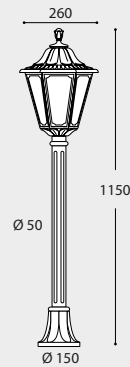

MEDIUM SIZE

RUT RANGE

"METAL POST COVERED BY RESIN"

STEEL
RESIN
EXPANSE

FumaTech
FUMAGALLI POLES TECHNOLOGY

ANTI RUST
LIFETIME GUARANTEE
NO PAINTING REQUIRED
MADE IN ITALY

ANTI CORROSION
UV-RAYS STABILIZED
NO MAINTENANCE
DOUBLE INSULATION
NOT AFFECTED BY CHEMICAL FERTILIZERS



ALOE'.R/RUT (resin)

6,5W FILAMENT 2700K	E26.163.F1R
8,5W CCT SET	E26.163.V1K
11W CCT SET	E26.163.T1K

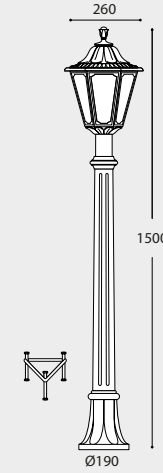

ARTU'.R/RUT

6,5W FILAMENT 2700K	E26.158.F1R
8,5W CCT SET	E26.158.V1K
11W CCT SET	E26.158.T1K

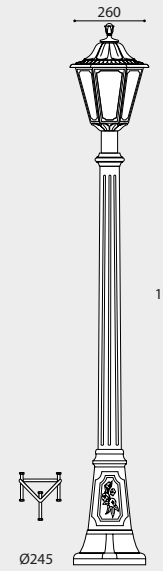

RICU BISSO/RUT 2L

6,5W FILAMENT 2700K	E26.157.S20.F1R
8,5W CCT SET	E26.157.S20.V1K
11W CCT SET	E26.157.S20.T1K

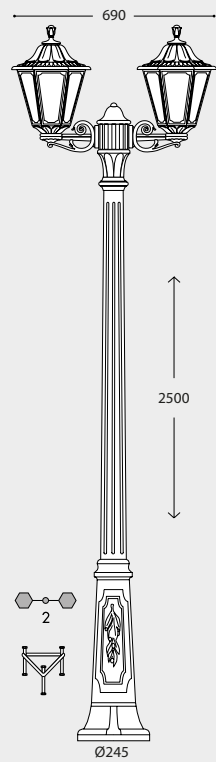

RICU BISSO/RUT 3L

6,5W FILAMENT 2700K	E26.157.S30.F1R
8,5W CCT SET	E26.157.S30.V1K
11W CCT SET	E26.157.S30.T1K

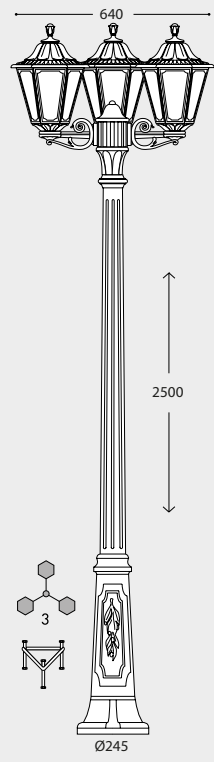

GIGI/RUT

6,5W FILAMENT 2700K	E26.156.F1R
8,5W CCT SET	E26.156.V1K
11W CCT SET	E26.156.T1K



RICU/RUT

6,5W FILAMENT 2700K	E26.157.F1R
8,5W CCT SET	E26.157.V1K
11W CCT SET	E26.157.T1K

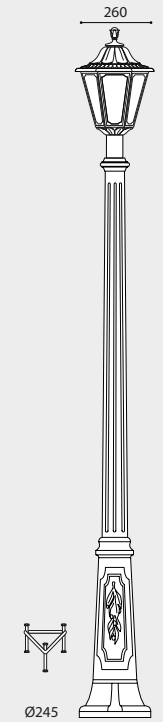

- 10 REVIVAL
- 32 GARDEN SMALL
- 48 GARDEN MEDIUM
- 68 GARDEN LARGE
- 84 HALF LANTERN
- 86 BOLLARD
- 92 BOLLARD
- 112 DOWNLIGHT
- 120 UP&DOWN
- 134 FLOODLIGHT
- 142 IN-GROUND
- 148 BRICKLIGHT
- 158 BULKHEAD
- 176 POST
- 184 SOLAR MODERN
- 192 SOLAR CLASSIC
- 194 LAMPS

SALEM RANGE

MEDIUM SIZE



MADE IN ITALY



K26.111.F1R

CCT SET	
6500K	2700K
6,5W 800 lm	8,5W 920 lm
2700 K	2700 K
	4000 K
	6500 K

More details at page 195



AVAILABLE COLORS			
RESIN BODY		DIFFUSER	
BLACK (A)	WHITE (W)	CLEAR (X)	OPAL (Y)

E27 CCT LED VERSION	
	11W 1200 lm 100-240V 50/60 Hz 2700K/4000K/6500K
CCT SET	75W INCANDESCENT

E27 FILAMENT LED VERSION	
	6,5W 800 lm 100-240V 50/60 Hz 2700K
CCT SET	60W INCANDESCENT

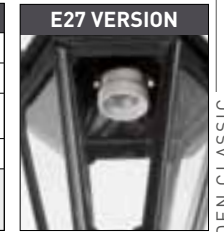

BISSO/SALEM

6,5W 2700K FILAMENT	K26.131.F1R
11W CCT SET	K26.131.T1K
E27	K26.131.E27

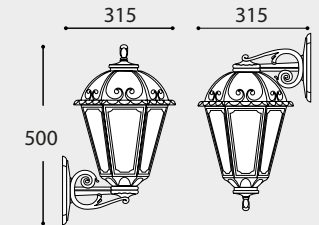

Master box: 12pcs

MINILOT/SALEM	
6,5W 2700K FILAMENT	K26.111.F1R
11W CCT SET	K26.111.T1K
E27	K26.111.E27

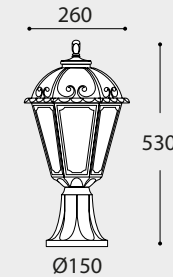

Master box: 12pcs

SICHEM/SALEM	
6,5W 2700K FILAMENT	K26.120.F1R
11W CCT SET	K26.120.T1K
E27	K26.120.E27

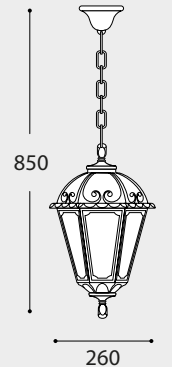

Master box: 12pcs

- 10 REVIVAL
- 32 GARDEN SMALL
- 48 GARDEN MEDIUM
- 68 GARDEN LARGE
- 84 HALF LANTERN
- 86 BOLLARD
- 92 BOLLARD
- 112 DOWNLIGHT
- 120 UP&DOWN
- 134 FLOODLIGHT
- 142 IN-GROUND
- 148 BRICKLIGHT
- 158 BULKHEAD
- 176 POST
- 184 SOLAR MODERN
- 192 SOLAR CLASSIC
- 194 LAMPS

SALEM RANGE

MEDIUM SIZE



AVAILABLE COLORS			
RESIN BODY		DIFFUSER	
BLACK (A)	WHITE (W)	CLEAR (X)	OPAL (Y)

E27 CCT LED VERSION	
8,5W	11W
920 lm	1200 lm
100-240V 50/60 Hz	100-240V 50/60 Hz
2700K/4000K/6500K	2700K/4000K/6500K
60W INCANDESCENT	75W INCANDESCENT

E27 FILAMENT LED VERSION	
6,5W	6,5W
800 lm	800 lm
100-240V 50/60 Hz	100-240V 50/60 Hz
2700K	2700K
60W INCANDESCENT	60W INCANDESCENT

MIZAR/SALEM (resin)

IP55

LED LAMP INCLUDED

6,5W FILAMENT 2700K	K26.151.F1R
8,5W CCT SET	K26.151.V1K
11W CCT SET	K26.151.T1K



MEDIUM SIZE

SALEM RANGE

"METAL POST COVERED BY RESIN"

STEEL
RESIN
EXPANSE

fumaTech
FUMAGALLI POLES TECHNOLOGY

ANTI RUST
LIFETIME GUARANTEE
NO PAINTING REQUIRED
MADE IN ITALY

ANTI CORROSION
UV-RAYS STABILIZED
NO MAINTENANCE
DOUBLE INSULATION
NOT AFFECTED BY CHEMICAL FERTILIZERS

ALOE'.R/SALEM (resin)

IP55

LED LAMP INCLUDED

6,5W FILAMENT 2700K	K26.163.F1R
8,5W CCT SET	K26.163.V1K
11W CCT SET	K26.163.T1K

ARTU'/SALEM

IP55

LED LAMP INCLUDED

6,5W FILAMENT 2700K	K26.158.F1R
8,5W CCT SET	K26.158.V1K
11W CCT SET	K26.158.T1K

RICU BISSO/SALEM 2L

IP55

LED LAMP INCLUDED

6,5W FILAMENT 2700K	K26.157.S20.F1R
8,5W CCT SET	K26.157.S20.V1K
11W CCT SET	K26.157.S20.T1K

RICU BISSO/SALEM 3L

IP55

LED LAMP INCLUDED

6,5W FILAMENT 2700K	K26.157.S30.F1R
8,5W CCT SET	K26.157.S30.V1K
11W CCT SET	K26.157.S30.T1K

GIGI/SALEM

IP55

LED LAMP INCLUDED

6,5W FILAMENT 2700K	K26.156.F1R
8,5W CCT SET	K26.156.V1K
11W CCT SET	K26.156.T1K

RICU/SALEM

IP55

LED LAMP INCLUDED

6,5W FILAMENT 2700K	K26.157.F1R
8,5W CCT SET	K26.157.V1K
11W CCT SET	K26.157.T1K

10	REVIVAL
32	GARDEN SMALL
48	GARDEN MEDIUM
68	GARDEN LARGE
84	HALF LANTERN
86	BOLLARD
92	BOLLARD
112	DOWNLIGHT
120	UP&DOWN
134	GARDEN MODERN
134	FLOODLIGHT
142	IN-GROUND
148	BRICKLIGHT
158	BULKHEAD
176	POST
184	SOLAR MODERN
192	SOLAR CLASSIC
194	LAMPS

GOLIA RANGE

MEDIUM SIZE



MADE IN ITALY

CCT SET		
6500K	4000K	2700K
6,5W 800 lm	8,5W 920 lm	11W 1200 lm
2700 K	2700 K	4000 K 6500 K

More details at page 195



Q23.131.F1R

UV-TREATED	ANTISHOCK	RECYCLABLE	CE	CB IEC60730	IP55	CLASS II
						DOUBLE INSULATION



AVAILABLE COLORS		E27 CCT LED VERSION	E27 FILAMENT LED VERSION	E27 VERSION
RESIN BODY	DIFFUSER	8,5W 920 lm 100-240V 50/60 Hz 2700K/4000K/6500K	6,5W 800 lm 100-240V 50/60 Hz 2700K	
BLACK (A)	WHITE (W)	CLEAR (X)	OPAL (Y)	
		60W INCANDESCENT	60W INCANDESCENT	

BISSO/GOLIA

6,5W 2700K FILAMENT	Q23.131.F1R
8,5W CCT SET	Q23.131.V1K
E27	Q23.131.E27

Master box: **12pcs**

MINILOT/GOLIA		SICHEM/GOLIA	
6,5W 2700K FILAMENT	Q23.111.F1R	6,5W 2700K FILAMENT	Q23.120.F1R
8,5W CCT SET	Q23.111.V1K	8,5W CCT SET	Q23.120.V1K
E27	Q23.111.E27	E27	Q23.120.E27

Master box: **12pcs**

Master box: **12pcs**

GARDEN CLASSIC

- 10 REVIVAL
- 32 GARDEN SMALL
- 48 GARDEN MEDIUM
- 68 GARDEN LARGE
- 84 HALF LANTERN
- 86 BOLLARD
- 92 BOLLARD
- 112 DOWNLIGHT
- 120 UP&DOWN
- 134 FLOODLIGHT
- 142 IN-GROUND
- 148 BRICKLIGHT
- 158 BULKHEAD
- 176 POST

SOLAR

- 184 SOLAR MODERN
- 192 SOLAR CLASSIC
- 194 LAMPS

GOLIA RANGE

MEDIUM SIZE



AVAILABLE COLORS

RESIN BODY		DIFFUSER	
BLACK (A)	WHITE (W)	CLEAR (X)	OPAL (Y)

E27 CCT LED VERSION

	8,5W
	920 lm
	100-240V
	50/60 Hz
	2700K/4000K/6500K
CCT SET	60W INCANDESCENT

E27 FILAMENT LED VERSION

	6,5W
	800 lm
	100-240V
	50/60 Hz
	2700K
CCT SET	60W INCANDESCENT



MEDIUM SIZE

GOLIA RANGE

"METAL POST COVERED BY RESIN"

FumaTech FUMAGALLI POLES TECHNOLOGY

STEEL
RESIN
EXPANSE

ANTI RUST LIFETIME GUARANTEE
NO PAINTING REQUIRED
MADE IN ITALY

ANTI CORROSION
UV-RAYS STABILIZED
NO MAINTENANCE
DOUBLE INSULATION
NOT AFFECTED BY CHEMICAL FERTILIZERS

MIZAR/GOLIA (resin)

IP55

6,5W FILAMENT	2700K	Q23.151.F1R
8,5W CCT SET		Q23.151.V1K

LED LAMP INCLUDED

ALOE'.R/GOLIA (resin)

IP55

6,5W FILAMENT	2700K	Q23.163.F1R
8,5W CCT SET		Q23.163.V1K

LED LAMP INCLUDED

ARTU'/GOLIA

IP55

6,5W FILAMENT	2700K	Q23.158.F1R
8,5W CCT SET		Q23.158.V1K

LED LAMP INCLUDED

RICU BISSO/GOLIA 2L

IP55

6,5W FILAMENT	2700K	Q23.157.S20.F1R
8,5W CCT SET		Q23.157.S20.V1K

LED LAMP INCLUDED

RICU BISSO/GOLIA 3L

IP55

6,5W FILAMENT	2700K	Q23.157.S30.F1R
8,5W CCT SET		Q23.157.S30.V1K

LED LAMP INCLUDED

GIGI/GOLIA

IP55

6,5W FILAMENT	2700K	Q23.156.F1R
8,5W CCT SET		Q23.156.V1K

LED LAMP INCLUDED

RICU/GOLIA

IP55

6,5W FILAMENT	2700K	Q23.157.F1R
8,5W CCT SET		Q23.157.V1K

LED LAMP INCLUDED

- 10 REVIVAL
- 32 GARDEN SMALL
- 48 GARDEN MEDIUM
- 68 GARDEN LARGE
- 84 HALF LANTERN
- 86 BOLLARD
- 92 BOLLARD
- 112 DOWNLIGHT
- 120 UP&DOWN
- 134 FLOODLIGHT
- 142 IN-GROUND
- 148 BRICKLIGHT
- 158 BULKHEAD
- 176 POST
- 184 SOLAR MODERN
- 192 SOLAR CLASSIC
- 194 LAMPS

CEFA RANGE

MEDIUM SIZE



MADE IN ITALY

CCT SET		
6,5W 800 lm 2700 K	8,5W 920 lm 2700 K	11W 1200 lm 4000 K 6500 K

More details at page 195



U23.120.F1R

UV-TREATED	ANTISHOCK	RECYCLABLE		IECEE CB SCHEME	IP55	CLASS II DOUBLE INSULATION



MEDIUM SIZE

CEFA RANGE

AVAILABLE COLORS				E27 CCT LED VERSION		E27 FILAMENT LED VERSION		E27 VERSION	
RESIN BODY		DIFFUSER							
					8,5W 920 lm 100-240V 50/60 Hz 2700K/4000K/6500K		6,5W 800 lm 100-240V 50/60 Hz 2700K		60W INCANDESCENT
BLACK (A)	WHITE (W)	CLEAR (X)	OPAL (Y)		60W INCANDESCENT		60W INCANDESCENT		

BISSO/CEFA

IP55	6,5W 2700K FILAMENT	U23.131.F1R
	8,5W CCT SET	U23.131.V1K
	E27	U23.131.E27

Master box: **12pcs**

MINILOT/CEFA			SICHEM/CEFA		
6,5W 2700K FILAMENT	U23.111.F1R		6,5W 2700K FILAMENT	U23.120.F1R	
8,5W CCT SET	U23.111.V1K		8,5W CCT SET	U23.120.V1K	
E27	U23.111.E27		E27	U23.120.E27	

Master box: **12pcs**

Master box: **12pcs**

10	REVIVAL
32	GARDEN SMALL
48	GARDEN MEDIUM
68	GARDEN LARGE
84	HALF LANTERN
86	BOLLARD
92	BOLLARD
112	DOWNLIGHT
120	UP&DOWN
134	FLOODLIGHT
142	IN-GROUND
148	BRICKLIGHT
158	BULKHEAD
176	POST
184	SOLAR MODERN
192	SOLAR CLASSIC
194	LAMPS

CEFA RANGE

MEDIUM SIZE



AVAILABLE COLORS

RESIN BODY		DIFFUSER	
BLACK (A)	WHITE (W)	CLEAR (X)	OPAL (Y)

E27 CCT LED VERSION

8,5W
920 lm
100-240V
50/60 Hz
2700K/4000K/6500K
60W INCANDESCENT

E27 FILAMENT LED VERSION

6,5W
800 lm
100-240V
50/60 Hz
2700K
60W INCANDESCENT



MEDIUM SIZE

CEFA RANGE

"METAL POST COVERED BY RESIN"

STEEL
RESIN
EXPANSE

FumaTech
FUMAGALLI POLES TECHNOLOGY

LIFETIME GUARANTEE
ANTI RUST
NO PAINTING REQUIRED
MADE IN ITALY

ANTI CORROSION
UV-RAYS STABILIZED
NO MAINTENANCE
DOUBLE INSULATION
NOT AFFECTED BY CHEMICAL FERTILIZERS

MIZAR/CEFA (resin)

LED LAMP INCLUDED

IP55

6,5W FILAMENT	2700K	U23.151.F1R
8,5W CCT SET		U23.151.V1K

230
1110
Ø50
Ø150

ALOE'.R/CEFA (resin)

LED LAMP INCLUDED

IP55

6,5W FILAMENT	2700K	U23.163.F1R
8,5W CCT SET		U23.163.V1K

230
1470
Ø190

ARTU'/CEFA

LED LAMP INCLUDED

IP55

6,5W FILAMENT	2700K	U23.158.F1R
8,5W CCT SET		U23.158.V1K

1865
Ø245

RICU BISSO/CEFA 2L

LED LAMP INCLUDED

IP55

6,5W FILAMENT	2700K	U23.157.S20.F1R
8,5W CCT SET		U23.157.S20.V1K

820
2450
Ø245

RICU BISSO/CEFA 3L

LED LAMP INCLUDED

IP55

6,5W FILAMENT	2700K	U23.157.S30.F1R
8,5W CCT SET		U23.157.S30.V1K

770
2450
Ø245

GIGI/CEFA

LED LAMP INCLUDED

IP55

6,5W FILAMENT	2700K	U23.156.F1R
8,5W CCT SET		U23.156.V1K

230
2130
Ø245

RICU/CEFA

LED LAMP INCLUDED

IP55

6,5W FILAMENT	2700K	U23.157.F1R
8,5W CCT SET		U23.157.V1K

230
2450
Ø245

- 10 GARDEN REVIVAL
- 32 GARDEN SMALL
- 48 GARDEN MEDIUM
- 68 GARDEN LARGE
- 84 HALF LANTERN
- 86 BOLLARD
- 92 BOLLARD
- 112 DOWNLIGHT
- 120 UP&DOWN
- 134 GARDEN MODERN FLOODLIGHT
- 142 IN-GROUND
- 148 BRICKLIGHT
- 158 BULKHEAD
- 176 POST
- 184 SOLAR SOLAR MODERN
- 192 SOLAR SOLAR CLASSIC
- 194 LAMPS

GLOBE 300 CLASSIC

MEDIUM SIZE



MADE IN ITALY

CCT SET		
6500K	4000K	2700K
6,5W 800 lm	8,5W 920 lm	11W 1200 lm
2700 K	2700 K	4000 K 6500 K

More details at page 195



G30.111.E27



G30.162.V1K



MEDIUM SIZE GLOBE 300 CLASSIC

AVAILABLE COLORS					E27 CCT LED VERSION		E27 FILAMENT LED VERSION		E27 VERSION
RESIN BODY		DIFFUSER			E27 CCT LED VERSION		E27 FILAMENT LED VERSION		E27 VERSION
						11W 1200 lm 100-240V 50/60 Hz 2700K/4000K/6500K		6,5W 800 lm 100-240V 50/60 Hz 2700K	
BLACK (A)	WHITE (W)	CLEAR (X)	OPAL (Y)	SMOKED (Z)		75W INCANDESCENT		60W INCANDESCENT	



BISSO/G300

6,5W 2700K FILAMENT	G30.131.F1R
11W	G30.131.T1K
E27	G30.131.E27

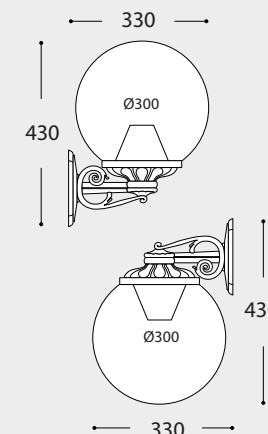

Master box: 24pcs

MINILOT/G300

6,5W 2700K FILAMENT	G30.111.F1R
11W	G30.111.T1K
E27	G30.111.E27



IP55

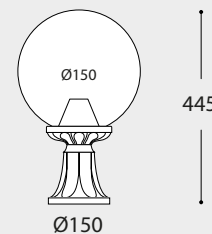

Master box: 24pcs

SICHEM/G300

6,5W 2700K FILAMENT	G30.120.F1R
11W	G30.120.T1K
E27	G30.120.E27



IP55

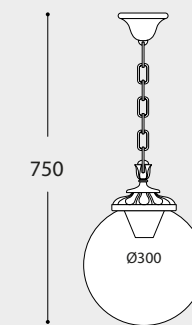

Master box: 24pcs

10	REVIVAL
32	GARDEN SMALL
48	GARDEN MEDIUM
68	GARDEN LARGE
84	HALF LANTERN
86	BOLLARD
92	BOLLARD
112	DOWNLIGHT
120	UP&DOWN
134	FLOODLIGHT
142	IN-GROUND
148	BRICKLIGHT
158	BULKHEAD
176	POST
184	SOLAR MODERN
192	SOLAR CLASSIC
194	LAMPS

GLOBE 300 CLASSIC MEDIUM SIZE



AVAILABLE COLORS				
RESIN BODY		DIFFUSER		
BLACK (A)	WHITE (W)	CLEAR (X)	OPAL (Y)	SMOKED (Z)

E27 CCT LED VERSION	
8,5W	11W
920 lm	1200 lm
100-240V 50/60 Hz	100-240V 50/60 Hz
2700K/4000K/6500K	2700K/4000K/6500K
60W INCANDESCENT	75W INCANDESCENT

E27 FILAMENT LED VERSION	
6,5WW	800 lm
100-240V 50/60 Hz	100-240V 50/60 Hz
2700K	2700K
60W INCANDESCENT	75W INCANDESCENT

IAFET.R/G300 (resin)

IP55

6,5W 2700K FILAMENT	G30.162.F1R
8,5W CCT SET	G30.162.V1K
11W CCT SET	G30.162.T1K

LED LAMP INCLUDED

Technical drawing showing a height of 1000 and a base diameter of Ø190.

Master box: **2pcs**



MEDIUM SIZE GLOBE 300 CLASSIC

"METAL POST COVERED BY RESIN"

STEEL
RESIN
EXPANSE

ANTI RUST
LIFETIME GUARANTEE
NO PAINTING REQUIRED
MADE IN ITALY

ANTI CORROSION
UV-RAYS STABILIZED
NO MAINTENANCE
DOUBLE INSULATION
NOT AFFECTED BY CHEMICAL FERTILIZERS

ALOE'.R/G300 (resin)

IP55

6,5W 2700K FILAMENT	G30.163.F1R
8,5W CCT SET	G30.163.V1K
11W CCT SET	G30.163.T1K

LED LAMP INCLUDED

Technical drawing showing a height of 1400 and a base diameter of Ø190.

Master box: **2pcs**

ARTU'/G300

IP55

6,5W 2700K FILAMENT	G30.158.F1R
8,5W CCT SET	G30.158.V1K
11W CCT SET	G30.158.T1K

LED LAMP INCLUDED

Technical drawing showing a height of 1760 and a base diameter of Ø245.

Master box: **2pcs**

RICU BISSO/G300 2L

IP55

6,5W 2700K FILAMENT	G30.157.S20.F1R
8,5W CCT SET	G30.157.S20.V1K
11W CCT SET	G30.157.S20.T1K

LED LAMP INCLUDED

Technical drawing showing a height of 2400 and a base diameter of Ø245.

Master box: **2pcs**

RICU BISSO/G300 3L

IP55

6,5W 2700K FILAMENT	G30.157.S30.F1R
8,5W CCT SET	G30.157.S30.V1K
11W CCT SET	G30.157.S30.T1K

LED LAMP INCLUDED

Technical drawing showing a height of 2400 and a base diameter of Ø245.

Master box: **2pcs**

GIGI/G300

IP55

6,5W 2700K FILAMENT	G30.156.F1R
8,5W CCT SET	G30.156.V1K
11W CCT SET	G30.156.T1K

LED LAMP INCLUDED

Technical drawing showing a height of 2010 and a base diameter of Ø245.

Master box: **2pcs**

RICU/G300

IP55

6,5W 2700K FILAMENT	G30.157.F1R
8,5W CCT SET	G30.157.V1K
11W CCT SET	G30.157.T1K

LED LAMP INCLUDED

Technical drawing showing a height of 2300 and a base diameter of Ø245.

Master box: **2pcs**

- 10 GARDEN REVIVAL
- 32 GARDEN SMALL
- 48 GARDEN MEDIUM
- 68 GARDEN LARGE
- 84 HALF LANTERN
- 86 BOLLARD
- 92 BOLLARD
- 112 DOWNLIGHT
- 120 UP&DOWN
- 134 FLOODLIGHT
- 142 IN-GROUND
- 148 BRICKLIGHT
- 158 BULKHEAD
- 176 POST
- 184 SOLAR MODERN
- 192 SOLAR CLASSIC
- 194 LAMPS

NOEMI RANGE

LARGE SIZE



MADE IN ITALY



E27 HIGH POWER LED

INDOOR & OUTDOOR USE

+80°C -30°C 90% HUMIDITY

VOLTAGE SURGE RESISTANT

15W (1690 lm)
30W (3620 lm)
50W (6550 lm)

More details at page 196



HIGH POWER LED VERSION

E35.132.Q1K



LARGE SIZE

NOEMI RANGE

AVAILABLE COLORS			
RESIN BODY		DIFFUSER	
BLACK (A)	WHITE (W)	CLEAR (X)	OPAL (Y)

E27 HIGH POWER LED VERSION	
15W 1690 lm 100-240V 50/60 Hz 4000K/3000K	30W 3620 lm 100-240V 50/60 Hz 4000K/3000K
= NOEMI 100W INCANDESCENT	= NOEMI 70W HQI-SON



OFIR/NOEMI

15W LED	CCT SET	E35.132.R1K
30W LED	CCT SET	E35.132.Q1K

HIGH POWER LED VERSION

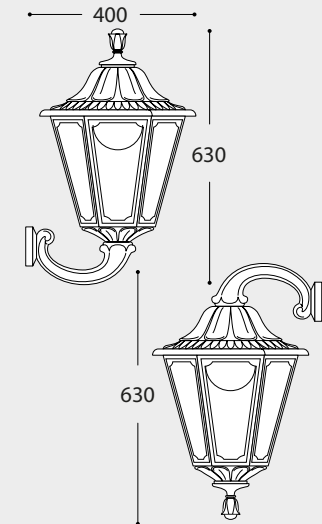

LOT/NOEMI

15W LED	CCT SET	E35.113.R1K
30W LED	CCT SET	E35.113.Q1K



HIGH POWER LED VERSION

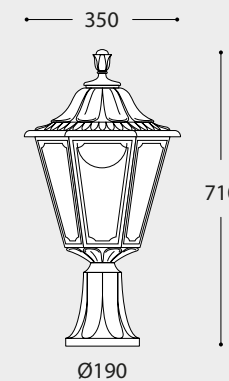

SICHEM/NOEMI

15W LED	CCT SET	E35.121.R1K
30W LED	CCT SET	E35.121.Q1K



HIGH POWER LED VERSION

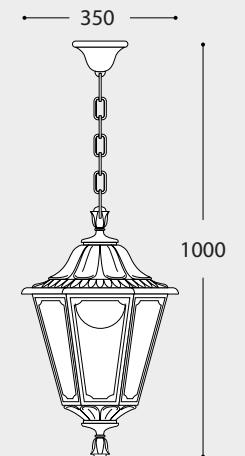

GARDEN CLASSIC

- 10 REVIVAL
- 32 GARDEN SMALL
- 48 GARDEN MEDIUM
- 68 GARDEN LARGE
- 84 HALF LANTERN
- 86 BOLLARD

GARDEN MODERN

- 92 BOLLARD
- 112 DOWNLIGHT
- 120 UP&DOWN
- 134 FLOODLIGHT
- 142 IN-GROUND
- 148 BRICKLIGHT
- 158 BULKHEAD
- 176 POST

SOLAR

- 184 SOLAR MODERN
- 192 SOLAR CLASSIC
- 194 LAMPS

NOEMI RANGE

LARGE SIZE



E27 HIGH POWER LED VERSION					
LAMP	POWER	LUMINOUS FLUX	VOLTAGE RANGE	CCT SETTABLE	COMPARISON
<p>E27 HIGH POWER LED Ø 100</p>	15W	1690 lm	100-240V 50/60 Hz	4000K/3000K	= NOEMI 100W INCANDESCENT
	30W	3620 lm	100-240V 50/60 Hz	4000K/3000K	= NOEMI 70W HQI-SO4

IAFET.R/NOEMI (resin)

IP55

15W LED	CCT SET	E35.162.R1K
30W LED	CCT SET	E35.162.Q1K

HIGH POWER LED VERSION

Master box: 2pcs

ARTU'/NOEMI	GIGI/NOEMI	RICU/NOEMI
15W LED CCT SET E35.158.R1K	15W LED CCT SET E35.156.R1K	15W LED CCT SET E35.157.R1K
30W LED CCT SET E35.158.Q1K	30W LED CCT SET E35.156.Q1K	30W LED CCT SET E35.157.Q1K

HIGH POWER LED VERSION

Master box: 2pcs

HIGH POWER LED VERSION

Master box: 2pcs

HIGH POWER LED VERSION

Master box: 2pcs



LARGE SIZE

NOEMI RANGE

"METAL POST COVERED BY RESIN"

STEEL
RESIN
EXPANSE

ANTI RUST
LIFETIME GUARANTEE
NO PAINTING REQUIRED
MADE IN ITALY

ANTI CORROSION
UV-RAYS STABILIZED
NO MAINTENANCE
DOUBLE INSULATION
NOT AFFECTED BY CHEMICAL FERTILIZERS

FumaTech®
FUMAGALLI POLES TECHNOLOGY

NEBO/NOEMI

30W LED CCT SET E35.201.Q1K

IP55

HIGH POWER LED VERSION

Ø275

NEBO OFIR/NOEMI 2L

30W LED CCT SET E35.201.R20.Q1K

IP55

HIGH POWER LED VERSION

Ø275

MADE IN ITALY

- 10 REVIVAL
- 32 GARDEN SMALL
- 48 GARDEN MEDIUM
- 68 GARDEN LARGE
- 84 HALF LANTERN
- 86 BOLLARD
- 92 BOLLARD
- 112 DOWNLIGHT
- 120 UP&DOWN
- 134 FLOODLIGHT
- 142 IN-GROUND
- 148 BRICKLIGHT
- 158 BULKHEAD
- 176 POST
- 184 SOLAR MODERN
- 192 SOLAR CLASSIC
- 194 LAMPS

SILOE RANGE

LARGE SIZE



MADE IN ITALY

HIGH POWER LED VERSION

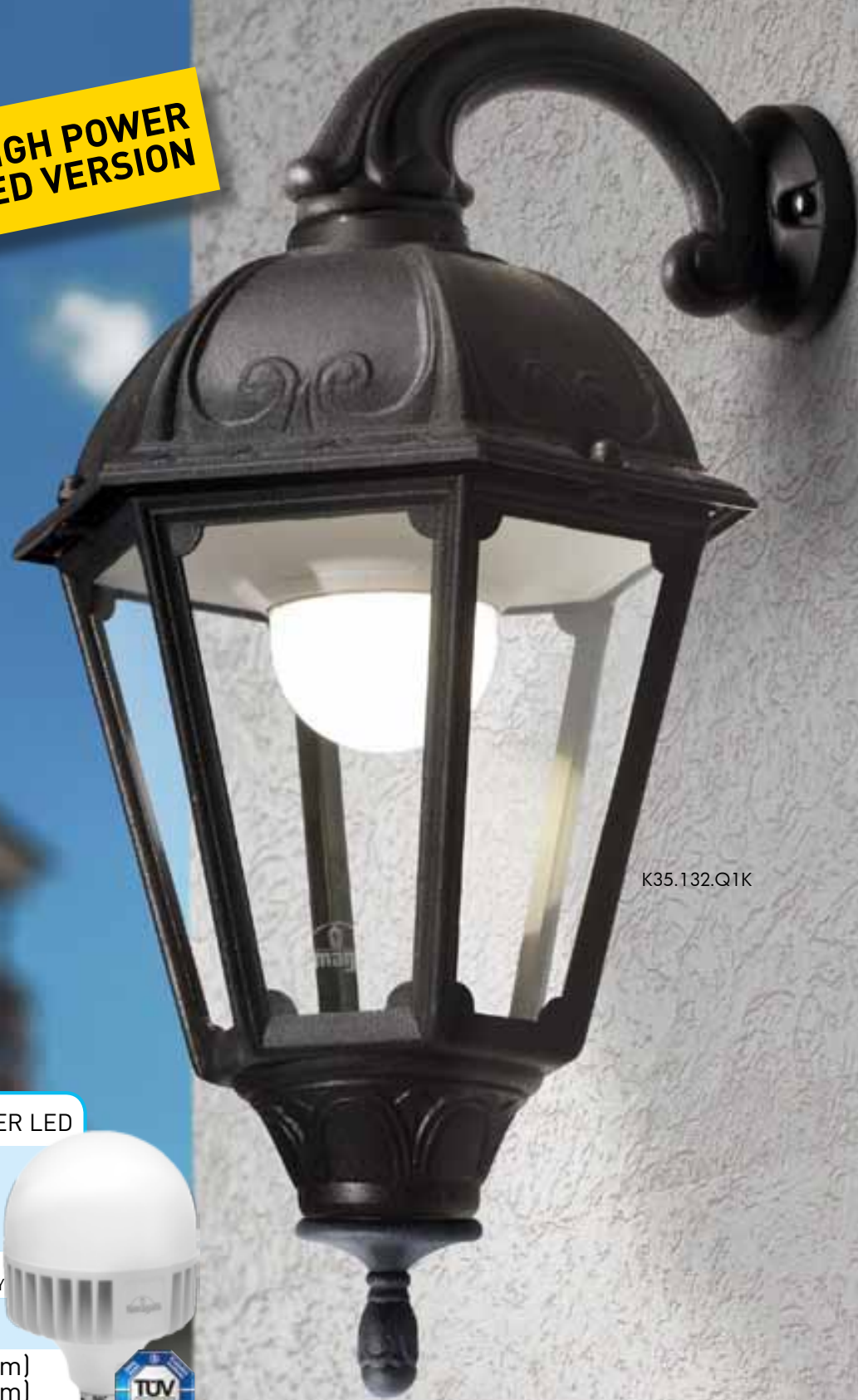

K35.132.Q1K

E27 HIGH POWER LED

INDOOR & OUTDOOR USE

+80°C
-30°C
90% HUMIDITY

VOLTAGE SURGE RESISTANT

15W (1690 lm)
30W (3620 lm)
50W (6550 lm)

More details at page 196

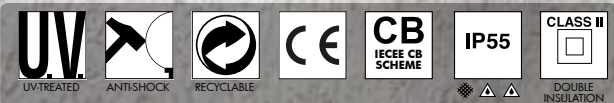

LARGE SIZE

SILOE RANGE

AVAILABLE COLORS			
RESIN BODY		DIFFUSER	
BLACK (A)	WHITE (W)	CLEAR (X)	OPAL (Y)

E27 HIGH POWER LED VERSION	
15W 1690 lm	30W 3620 lm
100-240V 50/60 Hz	100-240V 50/60 Hz
4000K/3000K	4000K/3000K
= SILOE 100W INCANDESCENT	= SILOE 70W HQI-SOON

OFIR/SILOE

15W LED	CCT SET	K35.132.R1K
30W LED	CCT SET	K35.132.Q1K

HIGH POWER LED VERSION

LOT/SILOE

15W LED	CCT SET	K35.113.R1K
30W LED	CCT SET	K35.113.Q1K

HIGH POWER LED VERSION

SICHEM/SILOE

15W LED	CCT SET	K35.121.R1K
30W LED	CCT SET	K35.121.Q1K

HIGH POWER LED VERSION

- 10 REVIVAL
- 32 GARDEN SMALL
- 48 GARDEN MEDIUM
- 68 GARDEN LARGE
- 84 HALF LANTERN
- 86 BOLLARD
- 92 BOLLARD
- 112 DOWNLIGHT
- 120 UP&DOWN
- 134 FLOODLIGHT
- 142 IN-GROUND
- 148 BRICKLIGHT
- 158 BULKHEAD
- 176 POST
- 184 SOLAR MODERN
- 192 SOLAR CLASSIC
- 194 LAMPS

SILOE RANGE

LARGE SIZE

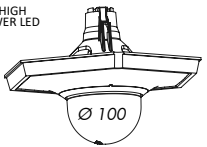

E27 HIGH POWER LED VERSION					
LAMP	POWER	LUMINOUS FLUX UP TO	VOLTAGE RANGE	CCT SETTABLE	COMPARISON
	15W	1690 lm	100-240V 50/60 Hz	4000K/3000K	= SILOE 100W INCANDESCENT
	30W	3620 lm	100-240V 50/60 Hz	4000K/3000K	= SILOE 70W HQI-SO

IAFET.R/SILOE (resin)



IP55

15W LED	CCT SET	K35.162.R1K
30W LED	CCT SET	K35.162.Q1K

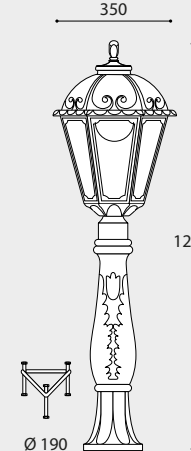

HIGH POWER LED VERSION

Master box: 2pcs

ARTU'/SILOE

GIGI/SILOE

RICU/SILOE



IP55

15W LED	CCT SET	K35.158.R1K	15W LED	CCT SET	K35.156.R1K	15W LED	CCT SET	K35.157.R1K
30W LED	CCT SET	K35.158.Q1K	30W LED	CCT SET	K35.156.Q1K	30W LED	CCT SET	K35.157.Q1K

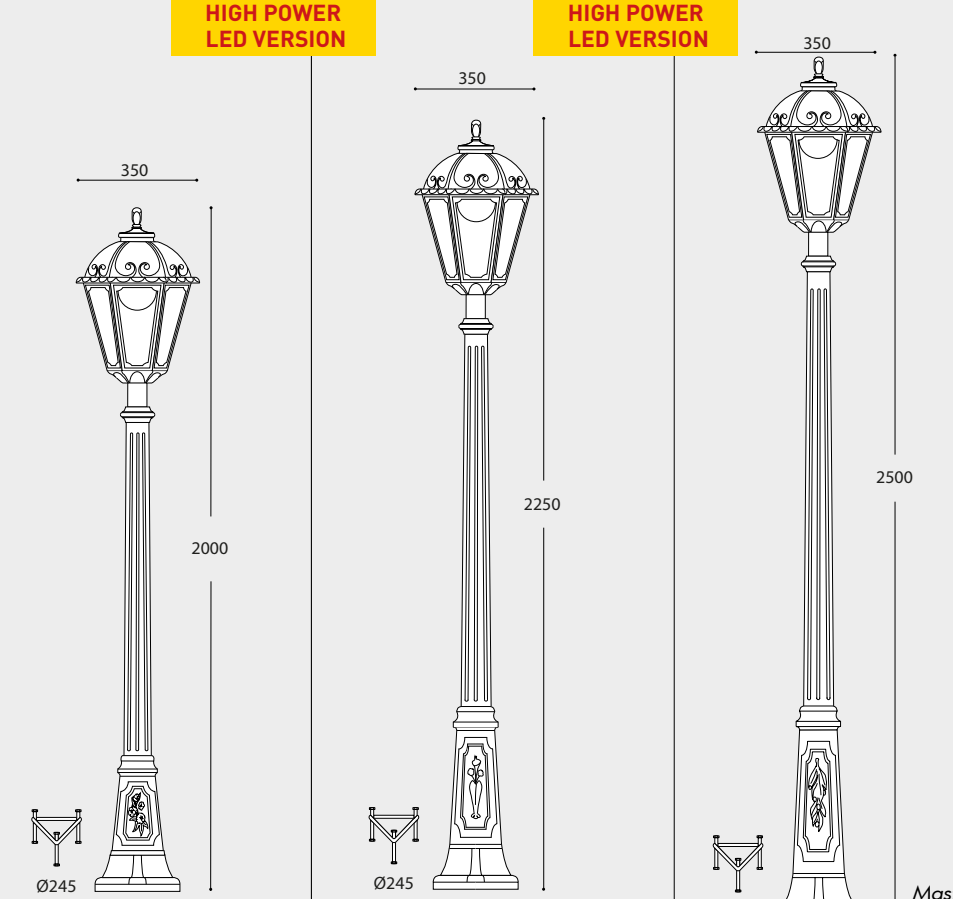

HIGH POWER LED VERSION

Master box: 2pcs



LARGE SIZE

SILOE RANGE

"METAL POST COVERED BY RESIN"



STEEL
RESIN
EXPANSE

ANTI RUST
LIFETIME GUARANTEE
NO PAINTING REQUIRED
MADE IN ITALY

ANTI CORROSION
UV-RAYS STABILIZED
NO MAINTENANCE
DOUBLE INSULATION
NOT AFFECTED BY CHEMICAL FERTILIZERS

NEBO/SILOE

NEBO OFIR/SILOE 2L



30W LED

IP55

CCT SET K35.201.Q1K

HIGH POWER LED VERSION



Ø245

30W LED

IP55

CCT SET K35.201.R20.Q1K

HIGH POWER LED VERSION



Ø275

- 10 REVIVAL
- 32 GARDEN SMALL
- 48 GARDEN MEDIUM
- 68 GARDEN LARGE
- 84 HALF LANTERN
- 86 BOLLARD
- 92 BOLLARD
- 112 DOWNLIGHT
- 120 UP&DOWN
- 134 FLOODLIGHT
- 142 IN-GROUND
- 148 BRICKLIGHT
- 158 BULKHEAD
- 176 POST
- 184 SOLAR MODERN
- 192 SOLAR CLASSIC
- 194 LAMPS

TOBIA RANGE

LARGE SIZE



HIGH POWER LED VERSION

MADE IN ITALY



Q33.113.Q1K

E27 HIGH POWER LED
INDOOR & OUTDOOR USE
 +80°C -30°C 90% HUMIDITY
 VOLTAGE SURGE RESISTANT
 15W (1690 lm)
 30W (3620 lm)
 50W (6550 lm)
 More details at page 196



LARGE SIZE **TOBIA RANGE**

AVAILABLE COLORS

RESIN BODY		DIFFUSER	
BLACK (A)	WHITE (W)	CLEAR (X)	OPAL (Y)

E27 HIGH POWER LED VERSION

15W	30W
1690 lm	3620 lm
100-240V 50/60 Hz	100-240V 50/60 Hz
4000K/3000K	4000K/3000K
= TOBIA 100W INCANDESCENT	= TOBIA 70W HQI-SON

OFIR/TOBIA

15W LED	CCT SET	Q33.132.R1K
30W LED	CCT SET	Q33.132.Q1K

HIGH POWER LED VERSION

LOT/TOBIA

15W LED	CCT SET	Q33.113.R1K
30W LED	CCT SET	Q33.113.Q1K

HIGH POWER LED VERSION

SICHEM/TOBIA

15W LED	CCT SET	Q33.121.R1K
30W LED	CCT SET	Q33.121.Q1K

HIGH POWER LED VERSION

GARDEN CLASSIC

- 10 REVIVAL
- 32 GARDEN SMALL
- 48 GARDEN MEDIUM
- 68 GARDEN LARGE
- 84 HALF LANTERN
- 86 BOLLARD
- 92 BOLLARD
- 112 DOWNLIGHT
- 120 UP&DOWN

GARDEN MODERN

- 134 FLOODLIGHT
- 142 IN-GROUND
- 148 BRICKLIGHT
- 158 BULKHEAD
- 176 POST

SOLAR

- 184 SOLAR MODERN
- 192 SOLAR CLASSIC
- 194 LAMPS

E27 HIGH POWER LED VERSION					
LAMP	POWER	LUMINOUS FLUX UP TO	VOLTAGE RANGE	CCT SETTABLE	COMPARISON
	15W	1690 lm	100-240V 50/60 Hz	4000K/3000K	= TOBIA 100W INCANDESCENT
	30W	3620 lm	100-240V 50/60 Hz	4000K/3000K	= TOBIA 70W HQI-SO ₄

IAFET.R/TOBIA (resin)

15W LED CCT SET	Q33.162.R1K
30W LED CCT SET	Q33.162.Q1K

HIGH POWER LED VERSION

Master box: 2pcs

ARTU'/TOBIA	GIGI/TOBIA	RICU/TOBIA
15W LED CCT SET Q33.158.R1K	15W LED CCT SET Q33.156.R1K	15W LED CCT SET Q33.157.R1K
30W LED CCT SET Q33.158.Q1K	30W LED CCT SET Q33.156.Q1K	30W LED CCT SET Q33.157.Q1K

HIGH POWER LED VERSION

Master box: 2pcs

"METAL POST COVERED BY RESIN"

STEEL, RESIN, EXPANSE

fumaTech
FUMAGALLI POLES TECHNOLOGY

ANTI RUST LIFETIME GUARANTEE NO PAINTING REQUIRED
MADE IN ITALY

ANTI CORROSION, UV-RAYS STABILIZED, NO MAINTENANCE, DOUBLE INSULATION, NOT AFFECTED BY CHEMICAL FERTILIZERS

NEBO/TOBIA

30W LED CCT SET Q33.201.Q1K

IP55

HIGH POWER LED VERSION

NEBO OFIR/TOBIA 2L

30W LED CCT SET Q33.201.R20.Q1K

IP55

HIGH POWER LED VERSION

- 10 REVIVAL
- 32 GARDEN SMALL
- 48 GARDEN MEDIUM
- 68 GARDEN LARGE
- 84 HALF LANTERN
- 86 BOLLARD
- 92 BOLLARD
- 112 DOWNLIGHT
- 120 UP&DOWN
- 134 FLOODLIGHT
- 142 IN-GROUND
- 148 BRICKLIGHT
- 158 BULKHEAD
- 176 POST
- 184 SOLAR MODERN
- 192 SOLAR CLASSIC
- 194 LAMPS

SIMON RANGE

LARGE SIZE



HIGH POWER LED VERSION

U33.132.Q1K

E27 HIGH POWER LED

INDOOR & OUTDOOR USE

+80°C
-30°C

90% HUMIDITY

VOLTAGE SURGE RESISTANT

15W (1690 lm)
30W (3620 lm)
50W (6550 lm)

More details at page 196



LARGE SIZE

SIMON RANGE

AVAILABLE COLORS			
RESIN BODY		DIFFUSER	
BLACK (A)	WHITE (W)	CLEAR (X)	OPAL (Y)

E27 HIGH POWER LED VERSION	
15W 1690 lm 100-240V 50/60 Hz 4000K/3000K = SIMON 100W INCANDESCENT	30W 3620 lm 100-240V 50/60 Hz 4000K/3000K = SIMON 70W HQI-SO

OFIR/SIMON

15W LED CCT SET	U33.132.R1K
30W LED CCT SET	U33.132.Q1K

HIGH POWER LED VERSION

LOT/SIMON

15W LED CCT SET	U33.113.R1K
30W LED CCT SET	U33.113.Q1K

HIGH POWER LED VERSION

SICHEM/SIMON

15W LED CCT SET	U33.121.R1K
30W LED CCT SET	U33.121.Q1K

HIGH POWER LED VERSION

- 10 REVIVAL
- 32 GARDEN SMALL
- 48 GARDEN MEDIUM
- 68 GARDEN LARGE
- 84 HALF LANTERN
- 86 BOLLARD
- 92 BOLLARD
- 112 DOWNLIGHT
- 120 UP&DOWN
- 134 FLOODLIGHT
- 142 IN-GROUND
- 148 BRICKLIGHT
- 158 BULKHEAD
- 176 POST
- 184 SOLAR MODERN
- 192 SOLAR CLASSIC
- 194 LAMPS

SIMON RANGE

LARGE SIZE



E27 HIGH POWER LED VERSION					
LAMP	POWER	LUMINOUS FLUX UP TO	VOLTAGE RANGE	CCT SETTABLE	COMPARISON
	15W	1690 lm	100-240V 50/60 Hz	4000K/3000K	= SIMON 100W INCANDESCENT
	30W	3620 lm	100-240V 50/60 Hz	4000K/3000K	= SIMON 70W HQI-SO ₄

IAFET.R/SIMON (resin)

IP55

15W LED	CCT SET	U33.162.R1K
30W LED	CCT SET	U33.162.Q1K

HIGH POWER LED VERSION

Master box: 2pcs

ARTU'/SIMON	GIGI/SIMON	RICU/SIMON
15W LED CCT SET U33.158.R1K	15W LED CCT SET U33.156.R1K	15W LED CCT SET U33.157.R1K
30W LED CCT SET U33.158.Q1K	30W LED CCT SET U33.156.Q1K	30W LED CCT SET U33.157.Q1K

HIGH POWER LED VERSION

Master box: 2pcs



LARGE SIZE

SIMON RANGE

"METAL POST COVERED BY RESIN"

STEEL, RESIN, EXPANSE

ANTI RUST LIFETIME GUARANTEE NO PAINTING REQUIRED

MADE IN ITALY

ANTI CORROSION, UV-RAYS STABILIZED, NO MAINTENANCE, DOUBLE INSULATION, NOT AFFECTED BY CHEMICAL FERTILIZERS

NEBO/SIMON

30W LED CCT SET U33.201.Q1K

IP55

HIGH POWER LED VERSION

NEBO OFIR/SIMON 2L

30W LED CCT SET U33.201.R20.Q1K

IP55

HIGH POWER LED VERSION

MADE IN ITALY

- 10 REVIVAL
- 32 GARDEN SMALL
- 48 GARDEN MEDIUM
- 68 GARDEN LARGE
- 84 HALF LANTERN
- 86 BOLLARD
- 92 BOLLARD
- 112 DOWNLIGHT
- 120 UP&DOWN
- 134 FLOODLIGHT
- 142 IN-GROUND
- 148 BRICKLIGHT
- 158 BULKHEAD
- 176 POST
- 184 SOLAR MODERN
- 192 SOLAR CLASSIC
- 194 LAMPS

IESSE-DARIA

HALF LANTERN



MADE IN ITALY



M22.000.F1R

CCT SET			
6,5W 800 lm 2700 K	8,5W 920 lm 2700 K	11W 1200 lm 4000 K	6500 K

More details at page 195

SMART PACK AVAILABLE

SINGLE BOX

cbm: 0,22
Master box:
16 pcs

NEW SMART PACK *

- Save 44 % volume
- ECO-friendly packaging
- Film wrapped items

SAVE 44% VOLUME

cbm: 0,14
Master box:
18 pcs



HALF LANTERNS

AVAILABLE COLORS		E27 CCT LED VERSION		E27 FILAMENT LED		E27 VERSION			
RESIN BODY		DIFFUSER		E27 CCT LED VERSION		E27 FILAMENT LED		E27 VERSION	
				8,5W 920 lm 100-240V 50/60 Hz 2700K/4000K/6500K	11W 1200 lm 100-240V 50/60 Hz 2700K/4000K/6500K	6,5W 800 lm 100-240V 50/60 Hz 2700K			
BLACK (A)	WHITE (W)	CLEAR (X)	OPAL (Y)	= 60W INCANDESCENT	= 75W INCANDESCENT	= 60W INCANDESCENT			

IESSE

IP55

6,5W FILAMENT 2700K	M22.000.F1R	SINGLE BOX
8,5W CCT SET	M22.000.V1K	SINGLE BOX
E27	M22.000.E27	SINGLE BOX

NEW SMART PACK *
E27 M23.000.E27

Standard Master box: **16pcs**
Smart pack Master box: **18pcs**

DARIA

IP55

6,5W FILAMENT 2700K	M28.000.F1R
11W CCT SET	M28.000.T1K
E27	M28.000.E27

10	REVIVAL
32	GARDEN SMALL
48	GARDEN MEDIUM
68	GARDEN LARGE
84	HALF LANTERN
86	BOLLARD
92	BOLLARD
112	DOWNLIGHT
120	UP&DOWN
134	FLOODLIGHT
142	IN-GROUND
148	BRICKLIGHT
158	BULKHEAD
176	POST
184	SOLAR MODERN
192	SOLAR CLASSIC
194	LAMPS

SAURO
BOLLARD



MADE IN ITALY



D15.554.E27FRA



SAURO E27 VERSIONS			
	with white resin louvre		with aluminium chrome louvre

AVAILABLE COLORS					
RESIN BODY (MOULDED COLOURS)			DIFFUSER		
BLACK (A)	GREY (L)	WHITE (W)	CLEAR (X)	OPAL (Y)	

SAURO 1100	
E27	D15.555.E27

SAURO 800	
E27	D15.554.E27

SAURO 500	
E27	D15.553.E27

MIRELLA	
E27	D15.505.E27

GARDEN CLASSIC

- 10 REVIVAL
- 32 GARDEN SMALL
- 48 GARDEN MEDIUM
- 68 GARDEN LARGE
- 84 HALF LANTERN
- 86 BOLLARD

GARDEN MODERN

- 92 BOLLARD
- 112 DOWNLIGHT
- 120 UP&DOWN
- 134 FLOODLIGHT
- 142 IN-GROUND
- 148 BRICKLIGHT
- 158 BULKHEAD
- 176 POST

SOLAR

- 184 SOLAR MODERN
- 192 SOLAR CLASSIC
- 194 LAMPS

SAURO BOLLARD



MADE IN ITALY

D15.554.D1KCRB



CCT SETTABLE

3000 K 4000 K 6500 K

SDCM <6

UV-TREATED ANTISHOCK RECYCLABLE CE CB IECCE CE SCHEME IP55 CLASS II DOUBLE INSULATION



SAURO GX53

SAURO LED VERSIONS					
LAMP	POWER	LUMINOUS FLUX (Φ TOTAL)	VOLTAGE RANGE	CCT SETTABLE	
	10W	1290 lm	100-240V 50/60 Hz	6500K/4000K/3000K	≈100W INCANDESCENT

AVAILABLE COLORS

RESIN BODY (MOULDED COLOURS)

BLACK (A) GREY (L) WHITE (W)

DIFFUSER

CLEAR (X) OPAL (Y)

SAURO 1100

10W CCT SET D15.555.D1KCRB

LAMP INCLUDED: GX53 LED

Technical drawing shows a height of 1100 and a diameter of Ø245.

SAURO 800

10W CCT SET D15.554.D1KCRB

LAMP INCLUDED: GX53 LED

Technical drawing shows a height of 800 and a diameter of Ø245.

SAURO 500

10W CCT SET D15.553.D1KCRB

LAMP INCLUDED: GX53 LED

Technical drawing shows a height of 500 and a diameter of Ø245.

MIRELLA

10W CCT SET D15.505.D1KCRB

LAMP INCLUDED: GX53 LED

Technical drawing shows a height of 520 and a diameter of 240.

MADE IN ITALY

- 10 REVIVAL
- 32 GARDEN SMALL
- 48 GARDEN MEDIUM
- 68 GARDEN LARGE
- 84 HALF LANTERN
- 86 BOLLARD
- 92 BOLLARD
- 112 DOWNLIGHT
- 120 UP&DOWN
- 134 FLOODLIGHT
- 142 IN-GROUND
- 148 BRICKLIGHT
- 158 BULKHEAD
- 176 POST
- 184 SOLAR MODERN
- 192 SOLAR CLASSIC
- 194 LAMPS



ESTER
for details see pag. 95



LIVIA 60
for details see pag.117



MAMETE
for details see pag. 121



LUCIA
for details see pag.173



STEVEN
for details see pag. 93



PROMO GARDEN 2024 - MODERN RANGE



CARLO 800
for details see pag.99



TERESA 90
for details see pag.114



ABRAM150
for details see pag.123



MINITOMMY-EL
for details see pag.133



EXTRALETI100 SQUARE
for details see pag. 154

STEVEN BOLLARD



MADE IN ITALY



ST1.531.Z1R



BOLLARD

STEVEN

STEVEN LED VERSIONS					AVAILABLE COLORS						
LAMP	POWER	LUMINOUS FLUX UP TO	VOLTAGE RANGE	COLOUR TEMPERATURE	BODY (MOULDED COLOURS)			DIFFUSER			
	1,7W	150 lm	100-240V 50/60 Hz	4000K	BLACK (A)	GREY (L)	WHITE (W)	FROSTED (X)	BLUE (U)	GREEN (N)	ORANGE (R)
				3000K							

STEVEN

LED G9 LAMP INCLUDED	1,7W	4000K	ST1.531.Z1L
		3000K	ST1.531.Z1R

SPIKE INSTALLATION

GROUND INSTALLATION

Master box: 10pcs

- 10 REVIVAL
- 32 GARDEN SMALL
- 48 GARDEN MEDIUM
- 68 GARDEN LARGE
- 84 HALF LANTERN
- 86 BOLLARD
- 92 BOLLARD
- 112 DOWNLIGHT
- 120 UP&DOWN
- 134 FLOODLIGHT
- 142 IN-GROUND
- 148 BRICKLIGHT
- 158 BULKHEAD
- 176 POST
- 184 SOLAR MODERN
- 192 SOLAR CLASSIC
- 194 LAMPS

ESTER BOLLARD



MADE IN ITALY



DS1.564.D1K

CCT SETTABLE

3000 K 4000 K 6500 K

SDCM <6



ESTER CCT LED VERSIONS					
LAMP	POWER	LUMINOUS FLUX (Φ TOTAL)	VOLTAGE RANGE	CCT SETTABLE	
	3W	410 lm	100-240V 50/60 Hz	6500K/4000K/3000K	=40W INCANDESCENT
	10W	1290 lm	100-240V 50/60 Hz	6500K/4000K/3000K	=100W INCANDESCENT

AVAILABLE COLORS			
RESIN BODY (MOULDED COLOURS)			DIFFUSER
BLACK (A)	GREY (L)	WHITE (W)	CLEAR (X)

ESTER 800

CCT SET LED GX53 LAMP INCLUDED	POWER	MODEL
3W	DS1.564.G1K	
10W	DS1.564.D1K	

Master box: **6pcs**

ESTER 500

CCT SET LED GX53 LAMP INCLUDED	POWER	MODEL
3W	DS1.563.G1K	
10W	DS1.563.D1K	

Master box: **12pcs**

ESTER WALL

CCT SET LED GX53 LAMP INCLUDED	POWER	MODEL
3W	DS1.560.G1K	
10W	DS1.560.D1K	

Master box: **18pcs**

ESTER SPIKE

CCT SET LED GX53 LAMP INCLUDED	POWER	MODEL
3W	DS1.561.G1K	
10W	DS1.561.D1K	

Master box: **18pcs**

GARDEN CLASSIC

- 10 REVIVAL
- 32 GARDEN SMALL
- 48 GARDEN MEDIUM
- 68 GARDEN LARGE
- 84 HALF LANTERN
- 86 BOLLARD

GARDEN MODERN

- 92 BOLLARD
- 112 DOWNLIGHT
- 120 UP&DOWN
- 134 FLOODLIGHT
- 142 IN-GROUND
- 148 BRICKLIGHT
- 158 BULKHEAD
- 176 POST

SOLAR

- 184 SOLAR MODERN
- 192 SOLAR CLASSIC
- 194 LAMPS

ELISA

BOLLARD



MADE IN ITALY



DS2.564.D1K

CCT SETTABLE

3000 K 4000 K 6500 K

SDCM <6



ELISA CCT LED VERSIONS					
LAMP	POWER	LUMINOUS FLUX (Φ TOTAL)	VOLTAGE RANGE	CCT SETTABLE	
	3W	410 lm	100-240V 50/60 Hz	6500K/4000K/3000K	=40W INCANDESCENT
	10W	1290 lm	100-240V 50/60 Hz	6500K/4000K/3000K	=100W INCANDESCENT

AVAILABLE COLORS	
RESIN BODY (MOULDED COLOURS)	DIFFUSER
<p>BLACK (A) GREY (L) WHITE (W)</p>	<p>CLEAR (X)</p>
WITH WHITE RESIN REFLECTOR	

ELISA 800

	3W	DS2.564.G1K
	10W	DS2.564.D1K

Master box: **6pcs**

ELISA 500

	3W	DS2.563.G1K
	10W	DS2.563.D1K

Master box: **12pcs**

ELISA WALL

	3W	DS2.560.G1K
	10W	DS2.560.D1K

Master box: **18pcs**

ELISA SPIKE

	3W	DS2.561.G1K
	10W	DS2.561.D1K

Master box: **18pcs**

- 10 REVIVAL
- 32 GARDEN SMALL
- 48 GARDEN MEDIUM
- 68 GARDEN LARGE
- 84 HALF LANTERN
- 86 BOLLARD
- 92 BOLLARD
- 112 DOWNLIGHT
- 120 UP&DOWN
- 134 FLOODLIGHT
- 142 IN-GROUND
- 148 BRICKLIGHT
- 158 BULKHEAD
- 176 POST
- 184 SOLAR MODERN
- 192 SOLAR CLASSIC
- 194 LAMPS

CARLO / CARLO DECO

BOLLARD



DR1.575.U1K



DR3.570.U1K



DR3.574.U1K

CCT SETTABLE

2700 K 4000 K

SDCM < 3



CARLO CCT LED VERSIONS					
LAMP	POWER	LUMINOUS FLUX (Φ TOTAL) UP TO	VOLTAGE RANGE	CCT SETTABLE	
GU10 LED	3,5W	366 lm	100-240V 50/60 Hz	4000K/2700K	=35W HALOGEN
GU10 LED	6W	615 lm	100-240V 50/60 Hz	4000K/2700K	=50W HALOGEN

AVAILABLE COLORS			
RESIN BODY (MOULDED COLOURS)			DIFFUSER
BLACK (A)	GREY (L)	WHITE (W)	CLEAR (X)

CARLO 800

LED GU10 LAMP INCLUDED

- 3,5W DR1.575.U1K
- 6W DR1.575.L1K
- 3,5W DR3.575.U1K
- 6W DR3.575.L1K

CARLO 800 DECO

CCT SET LED GU10 LAMP INCLUDED

Master box: **6pcs**

Master box: **6pcs**

CARLO 400

LED GU10 LAMP INCLUDED

- 3,5W DR1.574.U1K
- 6W DR1.574.L1K
- 3,5W DR3.574.U1K
- 6W DR3.574.L1K

CARLO 400 DECO

CCT SET LED GU10 LAMP INCLUDED

Master box: **12pcs**

Master box: **12pcs**

GARDEN CLASSIC

GARDEN MODERN

SOLAR

10	REVIVAL
32	GARDEN SMALL
48	GARDEN MEDIUM
68	GARDEN LARGE
84	HALF LANTERN
86	BOLLARD
92	BOLLARD
112	DOWNLIGHT
120	UP&DOWN
134	FLOODLIGHT
142	IN-GROUND
148	BRICKLIGHT
158	BULKHEAD
176	POST
184	SOLAR MODERN
192	SOLAR CLASSIC
194	LAMPS

CARLO LED VERSIONS					
LAMP	POWER	LUMINOUS FLUX (Φ TOTAL) UP TO	VOLTAGE RANGE	CCT SETTABLE	
GU10 LED	3,5W	366 lm	100-240V 50/60 Hz	4000K/2700K	= 35W HALOGEN
GU10 LED	6W	615 lm	100-240V 50/60 Hz	4000K/2700K	= 50W HALOGEN



CARLO 250

3,5W DR1.573.U1K

6W DR1.573.L1K

3,5W DR3.573.U1K

6W DR3.573.L1K

Master box: **20pcs**

CARLO 250 DECO

3,5W DR1.573.U1K

6W DR1.573.L1K

3,5W DR3.573.U1K

6W DR3.573.L1K

Master box: **20pcs**

CARLO SPIKE

3,5W DR1.572.U1K

6W DR1.572.L1K

3,5W DR3.572.U1K

6W DR3.572.L1K

Master box: **20pcs**

CARLO SPIKE DECO

3,5W DR1.572.U1K

6W DR1.572.L1K

3,5W DR3.572.U1K

6W DR3.572.L1K

Master box: **20pcs**

CARLO CCT LED VERSIONS					
LAMP	POWER	LUMINOUS FLUX (Φ TOTAL) UP TO	VOLTAGE RANGE	CCT SETTABLE	
GU10 LED	3,5W	366 lm	100-240V 50/60 Hz	4000K/2700K	= 35W HALOGEN
GU10 LED	6W	615 lm	100-240V 50/60 Hz	4000K/2700K	= 50W HALOGEN

AVAILABLE COLORS

RESIN BODY (MOULDED COLOURS)

BLACK (A) GREY (L) WHITE (W)

DIFFUSER

CLEAR (X)

CARLO WALL

3,5W DR1.570.U1K

6W DR1.570.L1K

3,5W DR3.570.U1K

6W DR3.570.L1K

Master box: **20pcs**

CARLO WALL DECO

3,5W DR1.570.U1K

6W DR1.570.L1K

3,5W DR3.570.U1K

6W DR3.570.L1K

Master box: **20pcs**

CARLO-FS

3,5W DR1.571.U1K

6W DR1.571.L1K

3,5W DR3.571.U1K

6W DR3.571.L1K

Master box: **20pcs**

CARLO-FS DECO

3,5W DR1.571.U1K

6W DR1.571.L1K

3,5W DR3.571.U1K

6W DR3.571.L1K

Master box: **20pcs**

GARDEN CLASSIC

10 REVIVAL

32 GARDEN SMALL

48 GARDEN MEDIUM

68 GARDEN LARGE

84 HALF LANTERN

86 BOLLARD

GARDEN MODERN

92 BOLLARD

112 DOWNLIGHT

120 UP&DOWN

134 FLOODLIGHT

142 IN-GROUND

148 BRICKLIGHT

158 BULKHEAD

176 POST

SOLAR

184 SOLAR MODERN

192 SOLAR CLASSIC

194 LAMPS

AMELIA

BOLLARD



CCT SET

8,5W 11W
920 lm 1200 lm
2700 K 4000 K 6500 K

More details at page 195



DR2.575.V1K

CCT SETTABLE

SDCM <6

2700 K 4000 K 6500 K



AMELIA CCT LED VERSIONS					
LAMP	POWER	LUMINOUS FLUX UP TO	VOLTAGE RANGE	COLOUR TEMPERATURE	
	8,5W	920 lm	100-240V 50/60 Hz	6500K/4000K/2700K	=60W INCANDESCENT
	11W	1200 lm	100-240V 50/60 Hz	6500K/4000K/2700K	=75W INCANDESCENT

AVAILABLE COLORS

RESIN BODY (MOULDED COLOURS)

BLACK (A) GREY (L) WHITE (W)

DIFFUSER

OPAL (V)

AMELIA 800

CCT SET LED E27 LAMP INCLUDED

8,5W	DR2.575.V1K
11W	DR2.575.T1K

Master box: **6pcs**

AMELIA 400

CCT SET LED E27 LAMP INCLUDED

8,5W	DR2.574.V1K
11W	DR2.574.T1K

Master box: **12pcs**

AMELIA 250

CCT SET LED E27 LAMP INCLUDED

8,5W	DR2.573.V1K
11W	DR2.573.T1K

Master box: **20pcs**

AMELIA SPIKE

CCT SET LED E27 LAMP INCLUDED

8,5W	DR2.572.V1K
11W	DR2.572.T1K

Master box: **20pcs**

- 10 REVIVAL
- 32 GARDEN SMALL
- 48 GARDEN MEDIUM
- 68 GARDEN LARGE
- 84 HALF LANTERN
- 86 BOLLARD
- 92 BOLLARD
- 112 DOWNLIGHT
- 120 UP&DOWN
- 134 FLOODLIGHT
- 142 IN-GROUND
- 148 BRICKLIGHT
- 158 BULKHEAD
- 176 POST
- 184 SOLAR MODERN
- 192 SOLAR CLASSIC
- 194 LAMPS

AMELIA

WALL LAMP



MADE IN ITALY



DR2.570.V1K

CCT SETTABLE

2700 K 4000 K 6500 K

SDCM <6



AMELIA CCT LED VERSIONS					
LAMP	POWER	LUMINOUS FLUX UP TO	VOLTAGE RANGE	COLOUR TEMPERATURE	
	8,5W	920 lm	100-240V 50/60 Hz	6500K/4000K/2700K	=60W INCANDESCENT
	11W	1200 lm	100-240V 50/60 Hz	6500K/4000K/2700K	=75W INCANDESCENT

AVAILABLE COLORS

RESIN BODY (MOULDED COLOURS)

BLACK (A) GREY (L) WHITE (W)

DIFFUSER

OPAL (V)

AMELIA WALL

CCT SET LED E27 LAMP INCLUDED	8,5W	DR2.570.V1K
	11W	DR2.570.T1K

Master box: **20pcs**

AMELIA-FS

CCT SET LED E27 LAMP INCLUDED	8,5W	DR2.571.V1K
	11W	DR2.571.T1K

Master box: **20pcs**

- 10 REVIVAL
- 32 GARDEN SMALL
- 48 GARDEN MEDIUM
- 68 GARDEN LARGE
- 84 HALF LANTERN
- 86 BOLLARD
- 92 BOLLARD
- 112 DOWNLIGHT
- 120 UP&DOWN
- 134 FLOODLIGHT
- 142 IN-GROUND
- 148 BRICKLIGHT
- 158 BULKHEAD
- 176 POST
- 184 SOLAR MODERN
- 192 SOLAR CLASSIC
- 194 LAMPS

GABRI-MINIGABRI REMI/LUCIA

BOLLARD



MADE IN ITALY



1R3.613.X10.E27

CCT SETTABLE

2700 K 4000 K 6500 K

SDCM <6



GABRI-MINIGABRI REMI/LUCIA

LED BULKHEAD GX53					
LAMP	POWER	LUMINOUS FLUX (Φ TOTAL)	VOLTAGE RANGE	CCT SETTABLE	
	11,3W	1510 lm	100-240V 50/60 Hz	6500K/4000K/2700K	≈100W INCANDESCENT
	17W	2350 lm	100-240V 50/60 Hz	6500K/4000K/2700K	≈150W INCANDESCENT

AVAILABLE COLORS			
RESIN BODY (MOULDED COLOURS)			DIFFUSER
BLACK (A)	GREY (L)	WHITE (W)	OPAL (Y)

GABRI REMI/LUCIA 1L					
	 LUCIA 1R3 LUCIA-EL 2R3 LUCIA-GD 3R3				
		E27	1R3.613.X10.E27	2R3.613.X10.E27	3R3.613.X10.E27
		GX53 LED 11,3W	1R3.613.X10.B1K	2R3.613.X10.B1K	3R3.613.X10.B1K
GX53 LED 17W	1R3.613.X10.E1K	2R3.613.X10.E1K	3R3.613.X10.E1K		

GABRI REMI/LUCIA 2L					
	 LUCIA 1R3 LUCIA-EL 2R3 LUCIA-GD 3R3				
		E27	1R3.613.X20.E27	2R3.613.X20.E27	3R3.613.X20.E27
		GX53 LED 11,3W	1R3.613.X20.B1K	2R3.613.X20.B1K	3R3.613.X20.B1K
GX53 LED 17W	1R3.613.X20.E1K	2R3.613.X20.E1K	3R3.613.X20.E1K		

MINIGABRI REMI/LUCIA 1L					
	 LUCIA 1R3 LUCIA-EL 2R3 LUCIA-GD 3R3				
		E27	1R3.612.X10.E27	2R3.612.X10.E27	3R3.612.X10.E27
		GX53 LED 11,3W	1R3.612.X10.B1K	2R3.612.X10.B1K	3R3.612.X10.B1K
GX53 LED 17W	1R3.612.X10.E1K	2R3.612.X10.E1K	3R3.612.X10.E1K		

MINIGABRI REMI/LUCIA 2L					
	 LUCIA 1R3 LUCIA-EL 2R3 LUCIA-GD 3R3				
		E27	1R3.612.X20.E27	2R3.612.X20.E27	3R3.612.X20.E27
		GX53 LED 11,3W	1R3.612.X20.B1K	2R3.612.X20.B1K	3R3.612.X20.B1K
GX53 LED 17W	1R3.612.X20.E1K	2R3.612.X20.E1K	3R3.612.X20.E1K		

10	REVIVAL
32	GARDEN SMALL
48	GARDEN MEDIUM
68	GARDEN LARGE
84	HALF LANTERN
86	BOLLARD
92	BOLLARD
112	DOWNLIGHT
120	UP&DOWN
134	FLOODLIGHT
142	IN-GROUND
148	BRICKLIGHT
158	BULKHEAD
176	POST
184	SOLAR MODERN
192	SOLAR CLASSIC
194	LAMPS

GABRI-MINIGABRI REMI/MADDI

BOLLARD



MADE IN ITALY



1V3.613.X20.E27

CCT SETTABLE

2700 K 4000 K 6500 K

SDCM <6



GABRI-MINIGABRI REMI/MADDI

LED BULKHEAD GX53					
LAMP	POWER	LUMINOUS FLUX (Φ TOTAL)	VOLTAGE RANGE	CCT SETTABLE	
	11,3W	1510 lm	100-240V 50/60 Hz	6500K/4000K/2700K	=100W INCANDESCENT
	17W	2350 lm	100-240V 50/60 Hz	6500K/4000K/2700K	=150W INCANDESCENT

AVAILABLE COLORS			
RESIN BODY (MOULDED COLOURS)			DIFFUSER
BLACK (A)	GREY (L)	WHITE (W)	OPAL (Y)

GABRI REMI/MADDI 1L				
		E27	1V3.613.X10.E27	2V3.613.X10.E27 3V3.613.X10.E27
		GX53 LED 11,3W	1V3.613.X10.B1K	2V3.613.X10.B1K 3V3.613.X10.B1K
		GX53 LED 17W	1V3.613.X10.E1K	2V3.613.X10.E1K 3V3.613.X10.E1K

GABRI REMI/MADDI 2L				
		E27	1V3.613.X20.E27	2V3.613.X20.E27 3V3.613.X20.E27
		GX53 LED 11,3W	1V3.613.X20.B1K	2V3.613.X20.B1K 3V3.613.X20.B1K
		GX53 LED 17W	1V3.613.X20.E1K	2V3.613.X20.E1K 3V3.613.X20.E1K

MINIGABRI REMI/MADDI 1L				
		E27	1V3.612.X10.E27	2V3.612.X10.E27 3V3.612.X10.E27
		GX53 LED 11,3W	1V3.612.X10.B1K	2V3.612.X10.B1K 3V3.612.X10.B1K
		GX53 LED 17W	1V3.612.X10.E1K	2V3.612.X10.E1K 3V3.612.X10.E1K

MINIGABRI REMI/MADDI 2L				
		E27	1V3.612.X20.E27	2V3.612.X20.E27 3V3.612.X20.E27
		GX53 LED 11,3W	1V3.612.X20.B1K	2V3.612.X20.B1K 3V3.612.X20.B1K
		GX53 LED 17W	1V3.612.X20.E1K	2V3.612.X20.E1K 3V3.612.X20.E1K

10	REVIVAL
32	GARDEN SMALL
48	GARDEN MEDIUM
68	GARDEN LARGE
84	HALF LANTERN
86	BOLLARD
92	BOLLARD
112	DOWNLIGHT
120	UP&DOWN
134	FLOODLIGHT
142	IN-GROUND
148	BRICKLIGHT
158	BULKHEAD
176	POST
184	SOLAR MODERN
192	SOLAR CLASSIC
194	LAMPS

PINELA-MINIPINELA

BOLLARD



MADE IN ITALY



2N1.613.010.P27

CCT SETTABLE

3000 K 4000 K 6500 K

SDCM <6



GERMANA LED VERSIONS					
LAMP	POWER	LUMINOUS FLUX (Φ TOTAL)	VOLTAGE RANGE	CCT SETTABLE	
2x GX53	2x3W 6W	820 lm	100-240V 50/60 Hz	6500K/4000K/3000K	=75W INCANDESCENT
2x GX53 LED	2x10W 20W	2570 lm	100-240V 50/60 Hz	6500K/4000K/3000K	=150W INCANDESCENT

AVAILABLE COLORS			
RESIN BODY (MOULDED COLOURS)			DIFFUSER
BLACK (A)	GREY (L)	WHITE (W)	OPAL (Y)

PINELA 1L

E27		2N1.613.010.P27
2x3W 6W	CCT SET	2N1.613.010.G2K
2x10W 20W	CCT SET	2N1.613.010.D2K

PINELA 2L

E27		2N1.613.020.P27
2x 6W	CCT SET	2N1.613.020.G2K
2x 20W	CCT SET	2N1.613.020.D2K

MINIPINELA 1L

E27		2N1.612.010.P27
2x3W 6W	CCT SET	2N1.612.010.G2K
2x10W 20W	CCT SET	2N1.612.010.D2K

MINIPINELA 2L

E27		2N1.612.020.P27
2x 6W	CCT SET	2N1.612.020.G2K
2x 20W	CCT SET	2N1.612.020.D2K

GARDEN CLASSIC

- 10 REVIVAL
- 32 GARDEN SMALL
- 48 GARDEN MEDIUM
- 68 GARDEN LARGE
- 84 HALF LANTERN
- 86 BOLLARD

GARDEN MODERN

- 92 BOLLARD
- 112 DOWNLIGHT
- 120 UP&DOWN
- 134 FLOODLIGHT
- 142 IN-GROUND
- 148 BRICKLIGHT
- 158 BULKHEAD
- 176 POST

SOLAR

- 184 SOLAR MODERN
- 192 SOLAR CLASSIC
- 194 LAMPS

TERESA RANGE

DOWNLIGHT / DECKLIGHT



MADE IN ITALY



TERESA 50
G9



TERESA 90
GU10



TERESA 160
GX53



TERESA 260
GX53
E27
E27+SENSOR **NEW**



TERESA 50 LED VERSIONS					AVAILABLE COLORS				
LAMP	POWER	LUMINOUS FLUX UP TO	VOLTAGE RANGE	COLOUR TEMPERATURE	COVER (MOULDED COLOURS)			DIFFUSER	
	1,7W	150 lm	100-240V 50/60 Hz	4000K 3000K	BLACK (A)	GREY (L)	WHITE (W)	FROSTED (X)	BLUE (U)
								GREEN (N)	ORANGE (R)

TERESA 50

4000K	210.000.Z1L
1,7W 3000K	210.000.Z1R

IP67

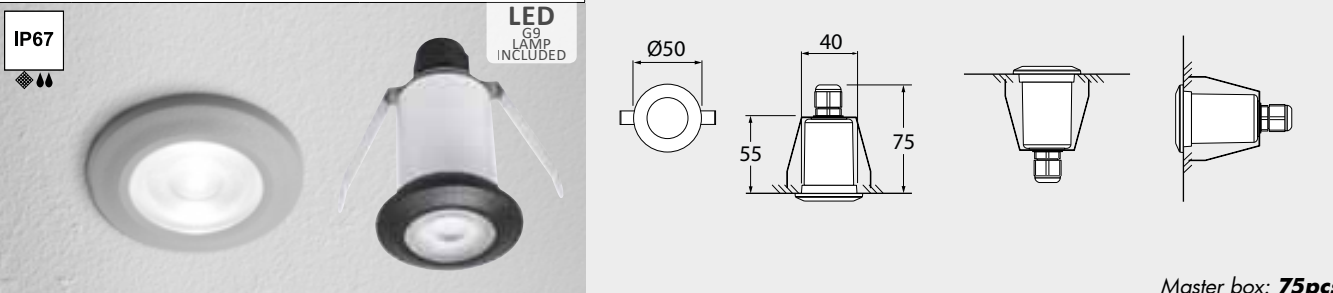

LED G9 LAMP INCLUDED

Master box: **75pcs**

TERESA 50 SQUARE

4000K	214.000.Z1L
1,7W 3000K	214.000.Z1R

IP67

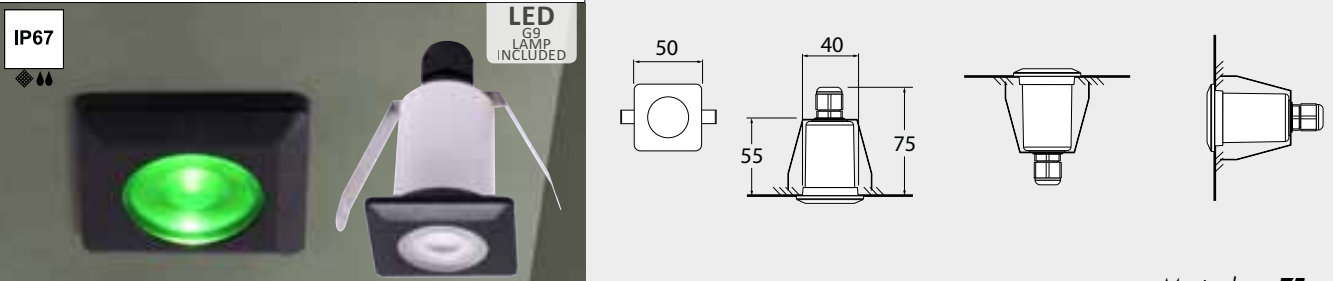

LED G9 LAMP INCLUDED

Master box: **75pcs**

TERESA 50 1L

4000K	211.000.Z1L
1,7W 3000K	211.000.Z1R

IP67

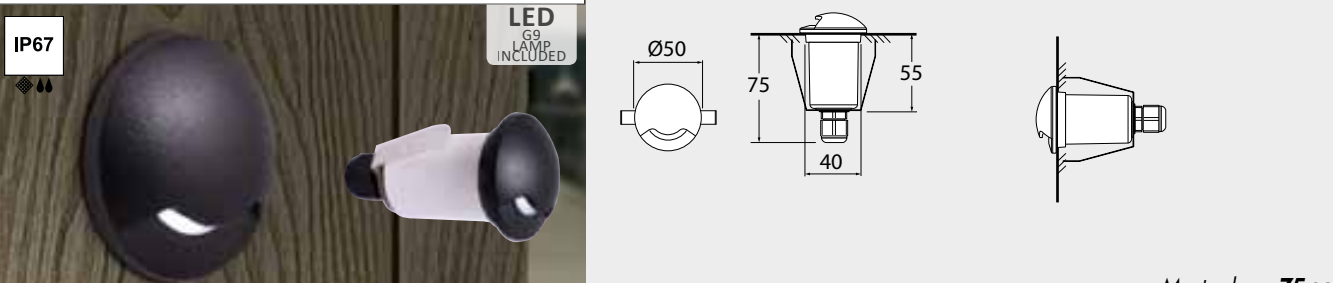

LED G9 LAMP INCLUDED

Master box: **75pcs**

TERESA 50 2L

4000K	212.000.Z1L
1,7W 3000K	212.000.Z1R

IP67

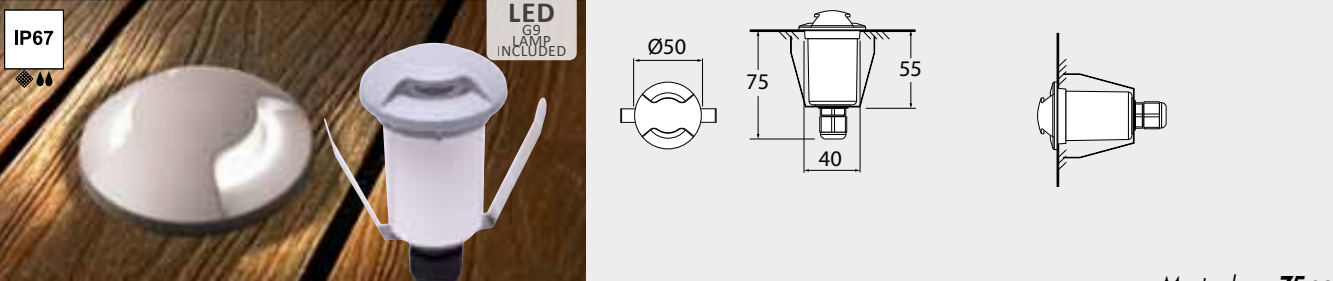

LED G9 LAMP INCLUDED

Master box: **75pcs**

GARDEN CLASSIC

10 REVIVAL

32 GARDEN SMALL

48 GARDEN MEDIUM

68 GARDEN LARGE

84 HALF LANTERN

86 BOLLARD

GARDEN MODERN

92 BOLLARD

112 DOWNLIGHT

120 UP&DOWN

134 FLOODLIGHT

142 IN-GROUND

148 BRICKLIGHT

158 BULKHEAD

176 POST

SOLAR

184 SOLAR MODERN

192 SOLAR CLASSIC

194 LAMPS

TERESA 90

DOWNLIGHT



TERESA 90 LED VERSIONS					
LAMP	POWER	LUMINOUS FLUX (Φ TOTAL) UP TO	VOLTAGE RANGE	CCT SETTABLE	
GU10 LED	3,5W	366 lm	100-240V 50/60 Hz	4000K/2700K	= 35W HALOGEN
GU10 LED	6W	615 lm	100-240V 50/60 Hz	4000K/2700K	= 50W HALOGEN

AVAILABLE COLORS	
RESIN BODY (MOULDED COLOURS)	DIFFUSER
BLACK (A) GREY (L) WHITE (W)	OPAL (Y)

TERESA 90

GU10 lampholder 3L1.000.GU1 **SMART PACK**

3,5W 3L0.000.U1K

6W 3L0.000.L1K

IP20
IP55

CCT SET
LED
GU10 LAMP INCLUDED

Standard Master box: **40 pcs**
Smart Pack Master box: **100 pcs**

TERESA 90

GU10 lampholder 3L1.000.GU1 **SMART PACK**

3,5W 3L0.000.U1K

6W 3L0.000.L1K

IP20
IP55

CCT SET
LED
GU10 LAMP INCLUDED

Standard Master box: **40 pcs**
Smart Pack Master box: **100 pcs**

TERESA 90 - AVAILABLE VERSIONS

TERESA 90 SINGLE BOX - LAMP INCLUDED

TERESA 90 GU10 + GU10 LAMP INCLUDED

cbm: **0,09**
Master box: **40 pcs**

TERESA 90 GU10 SMART PACK

5x TERESA 90 GU10

SAVE 37% VOLUME

- Save **37%** volume
- ECO-friendly packaging
- Film wrapped items

cbm: **0,14**
Master box: **5X20= 100 pcs**



DOWNLIGHT

TERESA 160

TERESA 160 CCT LED VERSIONS					
LAMP	POWER	LUMINOUS FLUX (Φ TOTAL)	VOLTAGE RANGE	CCT SETTABLE	
GX53	3W	410 lm	100-240V 50/60 Hz	6500K/4000K/3000K	= 40W INCANDESCENT
GX53	10W	1290 lm	100-240V 50/60 Hz	6500K/4000K/3000K	= 100W INCANDESCENT

TERESA 260 CCT LED VERSIONS					
LAMP	POWER	LUMINOUS FLUX (Φ TOTAL)	VOLTAGE RANGE	CCT SETTABLE	
GX53 LED	11,3W	1510 lm	100-240V 50/60 Hz	6500K/4000K/2700K	= 100W INCANDESCENT
GX53 LED	17W	2350 lm	100-240V 50/60 Hz	6500K/4000K/2700K	= 150W INCANDESCENT

TERESA 160

IP55

CCT SET
LED
GX53 LAMP INCLUDED

3W 4L0.000.G1K

10W 4L0.000.D1K

Master box: **18 pcs**

TERESA 160

IP55

CCT SET
LED
GX53 LAMP INCLUDED

3W 4L0.000.G1K

10W 4L0.000.D1K

Master box: **18 pcs**

TERESA 260

IP55

CCT SET
LED
GX53 LAMP INCLUDED

E27 lampholder 5L0.000.P27

11,3W 5L0.000.B1K

17W 5L0.000.E1K

Master box: **16 pcs**

TERESA 260

IP55

CCT SET
LED
GX53 LAMP INCLUDED

E27 lampholder 5L0.000.P27

11,3W 5L0.000.B1K

17W 5L0.000.E1K

Master box: **16 pcs**

SUPPLIED FULLY PRE-WIRED

GX53 LED

E27

E27+SENSOR

WITH SENSOR)))
220-240V
(E27)

10	REVIVAL
32	GARDEN SMALL
48	GARDEN MEDIUM
68	GARDEN LARGE
84	HALF LANTERN
86	BOLLARD
92	BOLLARD
112	DOWNLIGHT
120	UP&DOWN
134	FLOODLIGHT
142	IN-GROUND
148	BRICKLIGHT
158	BULKHEAD
176	POST
184	SOLAR MODERN
192	SOLAR CLASSIC
194	LAMPS

LIVIA RANGE

DOWNLIGHT



MADE IN ITALY



1A9.000.Z1L

AVAILABLE COLORS			
RESIN BODY <small>(MOULDED COLOURS)</small>			DIFFUSER
BLACK (A)	GREY (L)	WHITE (W)	FROSTED (X)



LIVIA 60 LED VERSIONS					LIVIA 90 CCT LED VERSIONS					
LAMP	POWER	LUMINOUS FLUX UP TO	VOLTAGE RANGE	COLOUR TEMPERATURE	LAMP	POWER	LUMINOUS FLUX (Φ TOTAL) UP TO	VOLTAGE RANGE	CCT SETTABLE	
	1,7W	150 lm	100-240V 50/60 Hz	4000K		3,5W	366 lm	100-240V 50/60 Hz	4000K/2700K	=35W HALOGEN
				3000K		6W	615 lm	100-240V 50/60 Hz	4000K/2700K	=50W HALOGEN

LIVIA 60

LED G9 LAMP INCLUDED	1,7W	4000K	1A9.000.Z1L
	3000K		1A9.000.Z1R

Master box: **75pcs**

LIVIA 90

CCT SET LED GU10 LAMP INCLUDED	3,5W	2A9.000.U1K
	6W	2A9.000.L1K

Master box: **30pcs**

GARDEN CLASSIC

- 10 REVIVAL
- 32 GARDEN SMALL
- 48 GARDEN MEDIUM
- 68 GARDEN LARGE
- 84 HALF LANTERN
- 86 BOLLARD
- 92 BOLLARD
- 112 DOWNLIGHT
- 120 UP&DOWN

GARDEN MODERN

- 134 FLOODLIGHT
- 142 IN-GROUND
- 148 BRICKLIGHT
- 158 BULKHEAD
- 176 POST

SOLAR

- 184 SOLAR MODERN
- 192 SOLAR CLASSIC
- 194 LAMPS

LIVIA RANGE DOWNLIGHT



MADE IN ITALY



3A9.000.G1K

AVAILABLE COLORS			
RESIN BODY <small>(MOULDED COLOURS)</small>			DIFFUSER
BLACK (A)	GREY (L)	WHITE (W)	FROSTED (X)



LIVIA 160 CCT LED VERSIONS						LIVIA 180 CCT LED VERSIONS					
LAMP	POWER	LUMINOUS FLUX (Φ TOTAL)	VOLTAGE RANGE	CCT SETTABLE		LAMP	POWER	LUMINOUS FLUX UP TO	VOLTAGE RANGE	CCT SETTABLE	
	3W	410 lm	100-240V 50/60 Hz	6500K/4000K/3000K	=40W INCANDESCENT		15W	1690 lm	100-240V 50/60 Hz	3000K/ 4000K	=50W HQI-SON
	10W	1290 lm	100-240V 50/60 Hz	6500K/4000K/3000K	=100W INCANDESCENT		30W	3620 lm	100-240V 50/60 Hz	3000K/ 4000K	=70W HQI-SON

LIVIA 160

CCT SET LED GX53 LAMP INCLUDED	POWER	MODEL
3W		3A9.000.G1K
10W		3A9.000.D1K

Master box: **18pcs**

LIVIA 180

CCT SET LED E27 HIGH POWER LAMP INCLUDED	POWER	MODEL
15W		4A9.000.R1K
30W		4A9.000.Q1K

Master box: **12pcs**

CCT SETTABLE

SDCM <6

3000 K 4000 K

GARDEN CLASSIC

GARDEN MODERN

SOLAR

- 10 REVIVAL
- 32 GARDEN SMALL
- 48 GARDEN MEDIUM
- 68 GARDEN LARGE
- 84 HALF LANTERN
- 86 BOLLARD
- 92 BOLLARD
- 112 DOWNLIGHT
- 120 UP&DOWN
- 134 FLOODLIGHT
- 142 IN-GROUND
- 148 BRICKLIGHT
- 158 BULKHEAD
- 176 POST
- 184 SOLAR MODERN
- 192 SOLAR CLASSIC
- 194 LAMPS

MAMETE

UP & DOWN



WALL INSTALLATION

2A3.000.Z1L



1A3.000.Z1L

GROUND INSTALLATION



MAMETE LED VERSIONS				
LAMP	POWER	LUMINOUS FLUX UP TO	VOLTAGE RANGE	COLOUR TEMPERATURE
	1,7W	150 lm	100-240V 50/60 Hz	4000K
				3000K

AVAILABLE COLORS						
BODY (MOULDED COLOURS)			DIFFUSER			
BLACK (A)	GREY (L)	WHITE (W)	FROSTED (X)	BLUE (U)	GREEN (N)	ORANGE (R)

MAMETE SQUARE

LED G9 LAMP INCLUDED	POWER	COLOUR TEMPERATURE	MODEL
	1,7W	4000K	1A3.000.Z1L
		3000K	1A3.000.Z1R

Master box: **50pcs**

MAMETE ROUND

LED G9 LAMP INCLUDED	POWER	COLOUR TEMPERATURE	MODEL
	1,7W	4000K	2A3.000.Z1L
		3000K	2A3.000.Z1R

Master box: **50pcs**

- 10 REVIVAL
- 32 GARDEN SMALL
- 48 GARDEN MEDIUM
- 68 GARDEN LARGE
- 84 HALF LANTERN
- 86 BOLLARD
- 92 BOLLARD
- 112 DOWNLIGHT
- 120 UP&DOWN
- 134 FLOODLIGHT
- 142 IN-GROUND
- 148 BRICKLIGHT
- 158 BULKHEAD
- 176 POST
- 184 SOLAR MODERN
- 192 SOLAR CLASSIC
- 194 LAMPS

ABRAM RANGE

UP&DOWN



MADE IN ITALY



AB1.000.J1K



ABRAM LED VERSIONS				
LAMP	POWER	LUMINOUS FLUX UP TO	VOLTAGE RANGE	CCT SETTABLE
R7s LED	3,5W	365 lm	100-240V 50/60 Hz	6500K/4000K/2700K
R7s LED	7,5W	790 lm	100-240V 50/60 Hz	6500K/4000K/2700K
R7s LED	10,5W	1160 lm	100-240V 50/60 Hz	6500K/4000K/2700K

RESIN BODY (MOULDED COLOURS)			DIFFUSER
BLACK (A)	GREY (L)	WHITE (W)	CLEAR (X)

ABRAM 150

LED R7s LAMP INCLUDED **3,5W** AB1.000.J1K

Master box: **30pcs**

ABRAM 190

LED R7s LAMP INCLUDED **7,5W** AB2.000.K1K

Master box: **30pcs**

ABRAM 270

LED R7s LAMP INCLUDED **10,5W** AB3.000.P1K

Master box: **14pcs**

CCT SETTABLE

2700 K 4000 K 6500 K

SDCM <6

GARDEN CLASSIC

- 10 REVIVAL
- 32 GARDEN SMALL
- 48 GARDEN MEDIUM
- 68 GARDEN LARGE
- 84 HALF LANTERN
- 86 BOLLARD

GARDEN MODERN

- 92 BOLLARD
- 112 DOWNLIGHT
- 120 UP&DOWN
- 134 FLOODLIGHT
- 142 IN-GROUND
- 148 BRICKLIGHT
- 158 BULKHEAD
- 176 POST

SOLAR

- 184 SOLAR MODERN
- 192 SOLAR CLASSIC
- 194 LAMPS

FRANCA 90

UP&DOWN



3A7.002.U1K

CCT SETTABLE

2700 K 4000 K

SDCM <3



FRANCA 90 CCT LED VERSIONS						
LAMP	POWER	LUMINOUS FLUX (Φ TOTAL) UP TO	VOLTAGE RANGE	CCT SETTABLE		
FRANCA 90 1L	GU10 LED	3,5W	366 lm	100-240V 50/60 Hz	4000K/2700K	=35W HALOGEN
	GU10 LED	6W	615 lm	100-240V 50/60 Hz	4000K/2700K	=50W HALOGEN
FRANCA 90 2L	2x GU10 LED	2x 3,5W 7W	732 lm	100-240V 50/60 Hz	4000K/2700K	=2 x 35W HALOGEN
	2x GU10 LED	2x 6W 12W	1230 lm	100-240V 50/60 Hz	4000K/2700K	=2 x 50W HALOGEN

AVAILABLE COLORS

BODY (MOULDED COLOURS)

BLACK (A) GREY (L) WHITE (W)

DIFFUSER

FROSTED (X) BLUE (U)

GREEN (N) ORANGE (R)

FRANCA 90

CCT SET LED GU10 LAMP INCLUDED	3,5W	3A7.000.U1K
	6W	3A7.000.L1K

Master box: 30pcs

FRANCA 90 SPIKE

CCT SET LED GU10 LAMP INCLUDED	3,5W	3A7.001.U1K
	6W	3A7.001.L1K

Master box: 30pcs

FRANCA 90-1L WALL

CCT SET LED GU10 LAMP INCLUDED	3,5W	3A7.002.U1K
	6W	3A7.002.L1K

Master box: 30pcs

FRANCA 90-2L WALL

CCT SET LED GU10 LAMP INCLUDED	2x3,5W 7W	3A7.003.U2K
	2x6W 12W	3A7.003.L2K

Master box: 20pcs

GARDEN CLASSIC

10 REVIVAL

32 GARDEN SMALL

48 GARDEN MEDIUM

68 GARDEN LARGE

84 HALF LANTERN

86 BOLLARD

GARDEN MODERN

92 BOLLARD

112 DOWNLIGHT

120 UP&DOWN

134 FLOODLIGHT

142 IN-GROUND

148 BRICKLIGHT

158 BULKHEAD

176 POST

SOLAR

184 SOLAR MODERN

192 SOLAR CLASSIC

194 LAMPS

MARTA 90

UP&DOWN



MADE IN ITALY



1A4.000.U1K

CCT SETTABLE

2700 K 4000 K

SDCM <3



MARTA 90 CCT LED VERSIONS						
LAMP	POWER	LUMINOUS FLUX (Φ TOTAL) UP TO	VOLTAGE RANGE	CCT SETTABLE		
MARTA 90 1L	GU10 LED	3,5W	366 lm	100-240V 50/60 Hz	4000K/2700K	=35W HALOGEN
	GU10 LED	6W	615 lm	100-240V 50/60 Hz	4000K/2700K	=50W HALOGEN
MARTA 90 2L	2x GU10 LED	2x 3,5W 7W	732 lm	100-240V 50/60 Hz	4000K/2700K	=2 x 35W HALOGEN
	2x GU10 LED	2x 6W 12W	1230 lm	100-240V 50/60 Hz	4000K/2700K	=2 x 50W HALOGEN

AVAILABLE COLORS

BODY (MOULDED COLOURS)

BLACK (A) GREY (L) WHITE (W)

DIFFUSER

FROSTED (X) BLUE (U)

GREEN (N) ORANGE (R)

MARTA90 1L

CCT SET LED GU10 LAMP INCLUDED	3,5W	1A4.000.U1K
	6W	1A4.000.L1K

Master box: **36pcs**

MARTA90 2L

CCT SET LED GU10 LAMP INCLUDED	2x3,5W 7W	2A4.000.U2K
	2x6W 12W	2A4.000.L2K

Master box: **36pcs**

- 10 REVIVAL
- 32 GARDEN SMALL
- 48 GARDEN MEDIUM
- 68 GARDEN LARGE
- 84 HALF LANTERN
- 86 BOLLARD
- 92 BOLLARD
- 112 DOWNLIGHT
- 120 UP&DOWN
- 134 FLOODLIGHT
- 142 IN-GROUND
- 148 BRICKLIGHT
- 158 BULKHEAD
- 176 POST
- 184 SOLAR MODERN
- 192 SOLAR CLASSIC
- 194 LAMPS

MARTA 160

UP&DOWN



MADE IN ITALY



1A6.000.G1K

CCT SETTABLE

3000 K 4000 K 6500 K

SDCM <6



MARTA 160

MARTA 160 CCT LED VERSIONS					
LAMP	POWER	LUMINOUS FLUX (Φ TOTAL)	VOLTAGE RANGE	CCT SETTABLE	
MARTA160 1L GX53	3W	410 lm	100-240V 50/60 Hz	6500K/4000K/3000K	=40W INCANDESCENT
	10W	1290 lm	100-240V 50/60 Hz	6500K/4000K/3000K	=100W INCANDESCENT
MARTA160 2L 2x GX53	2x3W 6W	820 lm	100-240V 50/60 Hz	6500K/4000K/3000K	=2x40W INCANDESCENT
	2x10W 20W	2580 lm	100-240V 50/60 Hz	6500K/4000K/3000K	=2x100W INCANDESCENT

AVAILABLE COLORS

BODY (MOULDED COLOURS)

BLACK (A) GREY (L) WHITE (W)

DIFFUSER

FROSTED (X) BLUE (U)

GREEN (N) ORANGE (R)

MARTA160 1L

E27	1A6.000.E27
3W	1A6.000.G1K
10W	1A6.000.D1K

CCT SET LED GX53 LAMP INCLUDED

Master box: **18pcs**

MARTA160 2L

2x3W 6W	2A6.000.G2K
2x10W 20W	2A6.000.D2K

CCT SET LED GX53 LAMP INCLUDED

Master box: **18pcs**

- 10 REVIVAL
- 32 GARDEN SMALL
- 48 GARDEN MEDIUM
- 68 GARDEN LARGE
- 84 HALF LANTERN
- 86 BOLLARD
- 92 BOLLARD
- 112 DOWNLIGHT
- 120 UP&DOWN
- 134 FLOODLIGHT
- 142 IN-GROUND
- 148 BRICKLIGHT
- 158 BULKHEAD
- 176 POST
- 184 SOLAR MODERN
- 192 SOLAR CLASSIC
- 194 LAMPS

FRANCY UP&DOWN



MADE IN ITALY

POWER	LUMINOUS FLUX	CCT SET
6,5W	800 lm	2700 K
8,5W	920 lm	2700 K
11W	1200 lm	4000 K
		6500 K

More details at page 195



1A1.000.F1R

SMART PACK AVAILABLE

SUPPLIED FULLY PRE-WIRED

2X GX53 LED	FILAMENT LED	CCT LED	E27	E27 + SENSOR
				WITH SENSOR))) 220-240V (.E27)



FRANCY LED VERSIONS					
LAMP	POWER	LUMINOUS FLUX UP TO	VOLTAGE RANGE	COLOUR TEMPERATURE	
	6,5W	800 lm	100-240V 50/60 Hz	2700K	=60W INCANDESCENT
	8,5W	920 lm	100-240V 50/60 Hz	6500K/4000K/2700K	=60W INCANDESCENT
	2x3W 6W	820 lm (Ø TOTAL)	100-240V 50/60 Hz	6500K/4000K/3000K	=75W INCANDESCENT

AVAILABLE COLORS			
RESIN BODY (MOULDED COLOURS)			DIFFUSER
BLACK (A)	GREY (L)	WHITE (W)	OPAL (Y)

FRANCY

E27	1A2.000.E27	SMART PACK
LED 6,5W FILAMENT LED 2700K	1A1.000.F1R	
E27 LAMP INCLUDED 8,5W CCT SET	1A1.000.V1K	

Standard Master box: **24pcs**
Smart Pack Master box: **42pcs**

FRANCY-OP

E27	2A2.000.E27	SMART PACK
E27	2A1.000.E27	SINGLE BOX
LED 6,5W FILAMENT LED 2700K	2A1.000.F1R	
E27 LAMP INCLUDED 2x3W 6W CCT SET	2A1.000.G2K	

Standard Master box: **24pcs**
Smart Pack Master box: **42pcs**

E27 AVAILABLE VERSIONS

FRANCY-OP E27 SINGLE BOX	FRANCY/FRANCY-OP E27 SMART PACK
cbm: 0,14 Master box: 24 pcs	SAVE 40% VOLUME X 42 <ul style="list-style-type: none"> Save 40% volume ECO-friendly packaging Film wrapped items cbm: 0,15 Master box: 42 pcs

GARDEN CLASSIC

- 10 REVIVAL
- 32 GARDEN SMALL
- 48 GARDEN MEDIUM
- 68 GARDEN LARGE
- 84 HALF LANTERN
- 86 BOLLARD
- 92 BOLLARD
- 112 DOWNLIGHT
- 120 UP&DOWN

GARDEN MODERN

- 134 FLOODLIGHT
- 142 IN-GROUND
- 148 BRICKLIGHT
- 158 BULKHEAD
- 176 POST

SOLAR

- 184 SOLAR MODERN
- 192 SOLAR CLASSIC
- 194 LAMPS

MINITOMMY FLOODLIGHT



MADE IN ITALY



1M1.001.U1K

CCT SETTABLE

2700 K 4000 K

SDCM < 3



MINITOMMY LED VERSIONS					
LAMP	POWER	LUMINOUS FLUX (@ TOTAL) UP TO	VOLTAGE RANGE	CCT SETTABLE	
MINITOMMY 1L GU10 LED	3,5W	366 lm	100-240V 50/60 Hz	4000K/2700K	= 35W HALOGEN
MINITOMMY 1L GU10 LED	6W	615 lm	100-240V 50/60 Hz	4000K/2700K	= 50W HALOGEN
MINITOMMY 2L 2x GU10 LED	2x 3,5W 7W	732 lm	100-240V 50/60 Hz	4000K/2700K	= 2 x 35W HALOGEN
MINITOMMY 2L 2x GU10 LED	2x 6W 12W	1230 lm	100-240V 50/60 Hz	4000K/2700K	= 2 x 50W HALOGEN

AVAILABLE COLORS	
COVER (MOULDED COLOURS)	DIFFUSER
BLACK (A) GREY (L) WHITE (W)	FROSTED (X) BLUE (U) GREEN (N) ORANGE (R)



MINITOMMY	
3,5W	1M1.000.U1K
6W	1M1.000.L1K

MINITOMMY SPIKE	
3,5W	1M1.001.U1K
6W	1M1.001.L1K



MINITOMMY-EL	
3,5W	1M2.000.U1K
6W	1M2.000.L1K

MINITOMMY-EL SPIKE	
3,5W	1M2.001.U1K
6W	1M2.001.L1K



MINITOMMY 2L	
2x 3,5W	3M1.000.U2K
2x 6W	3M1.000.L2K

MINITOMMY 2L SPIKE	
2x 3,5W	3M1.001.U2K
2x 6W	3M1.001.L2K



MINITOMMY-EL 2L	
2x 3,5W	3M2.000.U2K
2x 6W	3M2.000.L2K

MINITOMMY-EL 2L SPIKE	
2x 3,5W	3M2.001.U2K
2x 6W	3M2.001.L2K

10	REVIVAL
32	GARDEN SMALL
48	GARDEN MEDIUM
68	GARDEN LARGE
84	HALF LANTERN
86	BOLLARD
92	BOLLARD
112	DOWNLIGHT
120	UP&DOWN
134	FLOODLIGHT
142	IN-GROUND
148	BRICKLIGHT
158	BULKHEAD
176	POST
184	SOLAR MODERN
192	SOLAR CLASSIC
194	LAMPS

TOMMY FLOODLIGHT



MADE IN ITALY



2M1.000.D1K

CCT SETTABLE

3000 K 4000 K 6500 K

SDCM <6



TOMMY CCT LED VERSIONS					
LAMP	POWER	LUMINOUS FLUX (Φ TOTAL)	VOLTAGE RANGE	CCT SETTABLE	
GX53	3W	410 lm	100-240V 50/60 Hz	6500K/4000K/3000K	=40W INCANDESCENT
GX53	10W	1290 lm	100-240V 50/60 Hz	6500K/4000K/3000K	=100W INCANDESCENT

AVAILABLE COLORS			
COVER (MOULDED COLOURS)			DIFFUSER
BLACK (A)	GREY (L)	WHITE (W)	FROSTED (X) BLUE (U) GREEN (N) ORANGE (R)



TOMMY-SQ	
3W	5M1.000.G1K
10W	5M1.000.D1K

TOMMY-SQ SPIKE	
3W	5M1.001.G1K
10W	5M1.001.D1K

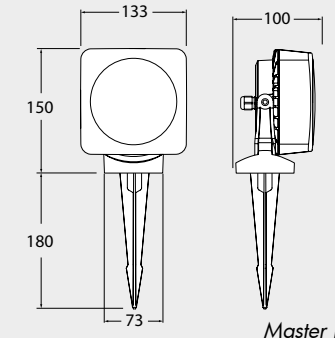
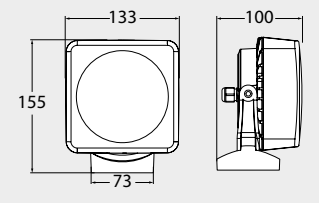

Master box: 18pcs

Master box: 18pcs



TOMMY	
3W	2M1.000.G1K
10W	2M1.000.D1K

TOMMY SPIKE	
3W	2M1.001.G1K
10W	2M1.001.D1K

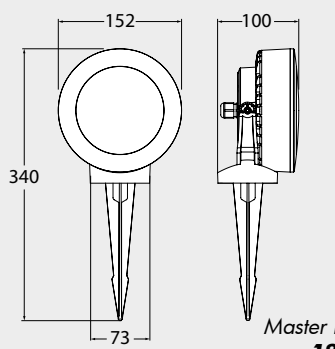
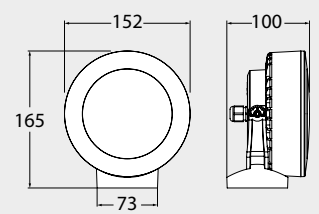

Master box: 18pcs

Master box: 18pcs



TOMMY-EL	
3W	2M2.000.G1K
10W	2M2.000.D1K

TOMMY-EL SPIKE	
3W	2M2.001.G1K
10W	2M2.001.D1K

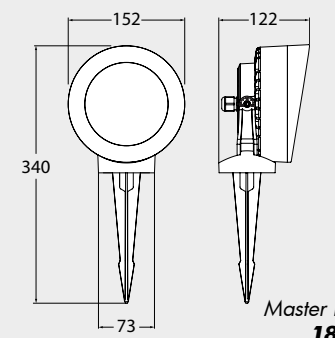
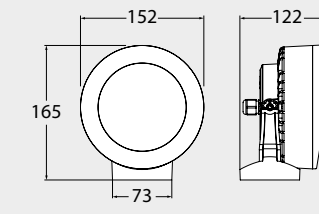

Master box: 18pcs

Master box: 18pcs

- 10 REVIVAL
- 32 GARDEN SMALL
- 48 GARDEN MEDIUM
- 68 GARDEN LARGE
- 84 HALF LANTERN
- 86 BOLLARD
- 92 BOLLARD
- 112 DOWNLIGHT
- 120 UP&DOWN
- 134 FLOODLIGHT
- 142 IN-GROUND
- 148 BRICKLIGHT
- 158 BULKHEAD
- 176 POST
- 184 SOLAR MODERN
- 192 SOLAR CLASSIC
- 194 LAMPS

TOMMY 2L FLOODLIGHT



MADE IN ITALY



4M1.001.D2K

CCT SETTABLE

3000 K 4000 K 6500 K

SDCM <6



TOMMY 2L

TOMMY 2L LED VERSIONS					
LAMP	POWER	LUMINOUS FLUX (Φ TOTAL)	VOLTAGE RANGE	CCT SETTABLE	
2x GX53	2x3W 6W	820 lm	100-240V 50/60 Hz	6500K/4000K/3000K	=75W INCANDESCENT
2x GX53 LED	2x10W 20W	2570 lm	100-240V 50/60 Hz	6500K/4000K/3000K	=150W INCANDESCENT

AVAILABLE COLORS			
COVER (MOULDED COLOURS)			DIFFUSER
BLACK (A)	GREY (L)	WHITE (W)	FROSTED (X) BLUE (U) GREEN (N) ORANGE (R)



TOMMY-SQ 2L	
2x3W 6W	6M1.000.G2K
2x10W 20W	6M1.000.D2K

TOMMY-SQ 2L SPIKE	
2x3W 6W	6M1.001.G2K
2x10W 20W	6M1.001.D2K

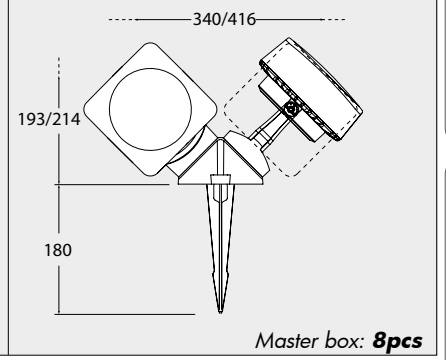
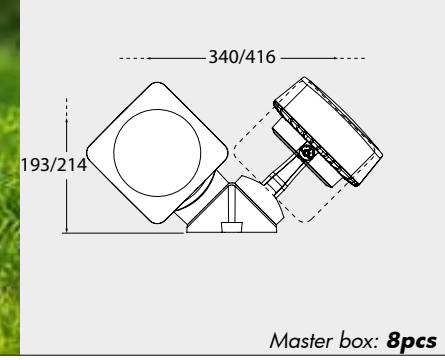

Master box: 8pcs

Master box: 8pcs



TOMMY 2L	
2x3W 6W	4M1.000.G2K
2x10W 20W	4M1.000.D2K

TOMMY 2L SPIKE	
2x3W 6W	4M1.001.G2K
2x10W 20W	4M1.001.D2K

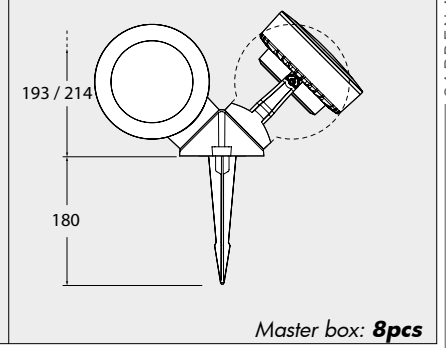
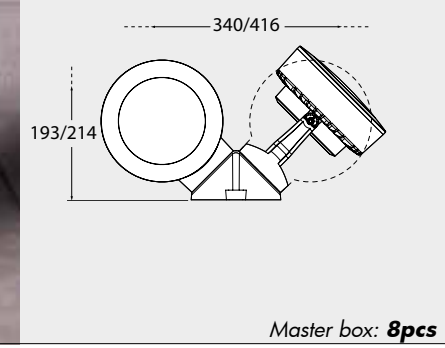

Master box: 8pcs

Master box: 8pcs



TOMMY-EL 2L	
2x3W 6W	4M2.000.G2K
2x10W 20W	4M2.000.D2K

TOMMY-EL 2L SPIKE	
2x3W 6W	4M2.001.G2K
2x10W 20W	4M2.001.D2K

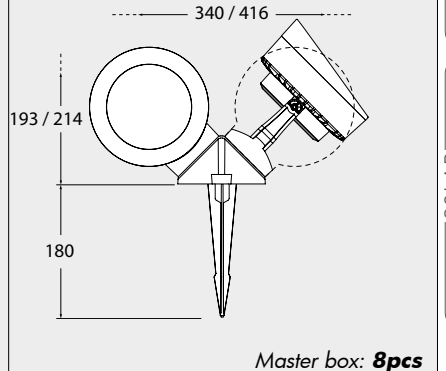
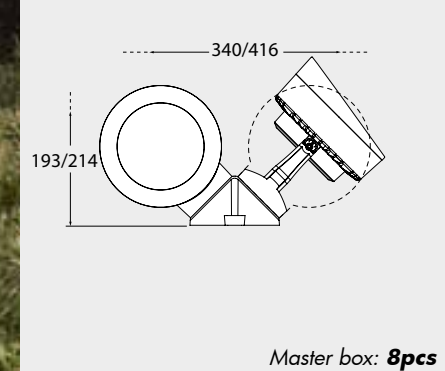

Master box: 8pcs

Master box: 8pcs

GARDEN CLASSIC

10 REVIVAL

32 GARDEN SMALL

48 GARDEN MEDIUM

68 GARDEN LARGE

84 HALF LANTERN

86 BOLLARD

92 BOLLARD

112 DOWNLIGHT

120 UP&DOWN

GARDEN MODERN

134 FLOODLIGHT

142 IN-GROUND

148 BRICKLIGHT

158 BULKHEAD

176 POST

SOLAR

184 SOLAR MODERN

192 SOLAR CLASSIC

194 LAMPS

GERMANA FLOODLIGHT



2N1.000.P27

CCT SETTABLE

3000 K 4000 K 6500 K

SDCM <6

SUPPLIED FULLY PRE-WIRED



WITH SENSOR)))
220-240V
(.PS7)



GERMANA LED VERSIONS					
LAMP	POWER	LUMINOUS FLUX (Φ TOTAL)	VOLTAGE RANGE	CCT SETTABLE	
2x GX53	2x3W 6W	820 lm	100-240V 50/60 Hz	6500K/4000K/3000K	=75W INCANDESCENT
2x GX53 LED	2x10W 20W	2570 lm	100-240V 50/60 Hz	6500K/4000K/3000K	=150W INCANDESCENT

AVAILABLE COLORS			
RESIN BODY (MOULDED COLOURS)			DIFFUSER
BLACK (A)	GREY (L)	WHITE (W)	OPAL (Y)

GERMANA

E27	2N1.000.P27
CCT SET LED GX53 LAMP INCLUDED 2x3W 6W	2N1.000.G2K
2x10W 20W	2N1.000.D2K

Master box: **18pcs**

GIOVA/GERMANA

E27	2N1.702.P27
CCT SET LED GX53 LAMP INCLUDED 2x3W 6W	2N1.702.G2K
2x10W 20W	2N1.702.D2K

Master box: **18pcs**

GARDEN CLASSIC

- 10 REVIVAL
- 32 GARDEN SMALL
- 48 GARDEN MEDIUM
- 68 GARDEN LARGE
- 84 HALF LANTERN
- 86 BOLLARD

GARDEN MODERN

- 92 BOLLARD
- 112 DOWNLIGHT
- 120 UP&DOWN
- 134 FLOODLIGHT
- 142 IN-GROUND
- 148 BRICKLIGHT
- 158 BULKHEAD
- 176 POST

SOLAR

- 184 SOLAR MODERN
- 192 SOLAR CLASSIC
- 194 LAMPS

GIUSEPPE FLOODLIGHT



MADE IN ITALY



4P2.000.E28

SUPPLIED FULLY PRE-WIRED

GX53 LED	GX53 LED + SENSOR	4x GX53 LED	2x E27	2x E27 + SENSOR
	WITH SENSOR))) (220-240V) 11,3W CCT (.BSK) 17W CCT (.ESK)			WITH SENSOR))) 220-240V (.ES8)



GIUSEPPE LED VERSIONS					
LAMP	POWER	LUMINOUS FLUX (Φ TOTAL)	VOLTAGE RANGE	CCT SETTABLE	
	11,3W	1510 lm	100-240V 50/60 Hz	6500K/4000K/2700K	=100W INCANDESCENT
	17W	2350 lm	100-240V 50/60 Hz	6500K/4000K/2700K	=150W INCANDESCENT
4x GX53	4x10W 40W	5160 lm	100-240V 50/60 Hz	6500K/4000K/3000K	=100W HQI-SOON

AVAILABLE COLORS			
RESIN BODY (MOULDED COLOURS)			DIFFUSER
BLACK (A)	GREY (L)	WHITE (W)	OPAL (Y)

GIUSEPPE

2x E27	4P2.000.E28
11,3W	4P1.000.B1K
17W	4P1.000.E1K
4x10W 40W	4P2.000.D4K

CCT SET
LED GX53 LAMP INCLUDED

Master box: 10pcs

GIOVA/GIUSEPPE

2x E27	4P2.702.E28
11,3W	4P1.702.B1K
17W	4P1.702.E1K
4x10W 40W	4P2.702.D4K

CCT SET
LED GX53 LAMP INCLUDED





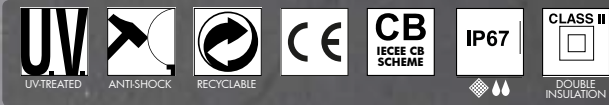

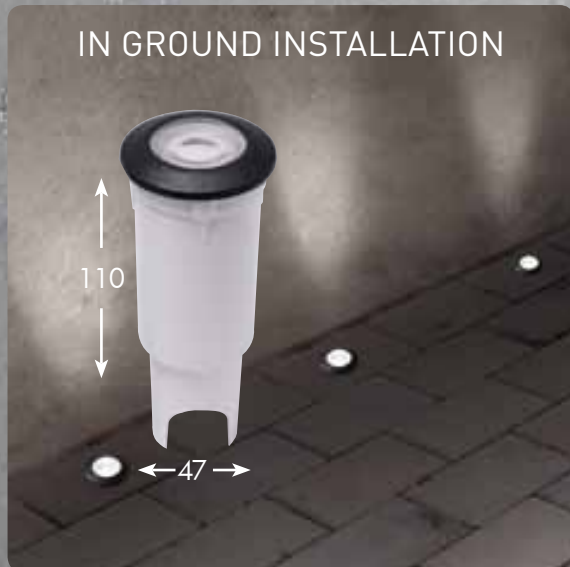

Master box: 10pcs

- 10 REVIVAL
- 32 GARDEN SMALL
- 48 GARDEN MEDIUM
- 68 GARDEN LARGE
- 84 HALF LANTERN
- 86 BOLLARD
- 92 BOLLARD
- 112 DOWNLIGHT
- 120 UP&DOWN
- 134 FLOODLIGHT
- 142 IN-GROUND
- 148 BRICKLIGHT
- 158 BULKHEAD
- 176 POST
- 184 SOLAR MODERN
- 192 SOLAR CLASSIC
- 194 LAMPS



1L1.000.Z1L





ALDO LED VERSIONS					AVAILABLE COLORS				
LAMP	POWER	LUMINOUS FLUX UP TO	VOLTAGE RANGE	COLOUR TEMPERATURE	COVER (MOULDED COLOURS)			DIFFUSER	
	1,7W	150 lm	100-240V 50/60 Hz	4000K 3000K					
									

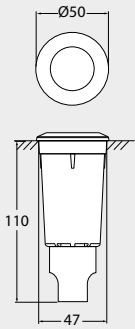
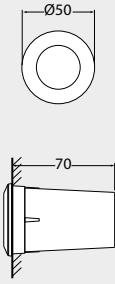

ALDO

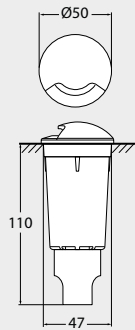
IN GROUND		1,7W 4000K 3000K	110.000.Z1L 110.000.Z1R		RECESSED	
Master box: 75pcs						

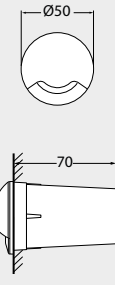
ALDO 1L

IN GROUND		1,7W 4000K 3000K	111.000.Z1L 111.000.Z1R		RECESSED	
Master box: 75pcs						

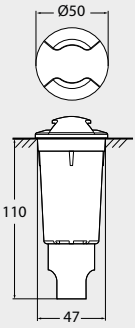
ALDO 2L

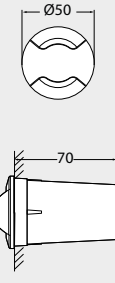
IN GROUND		1,7W 4000K 3000K	112.000.Z1L 112.000.Z1R		RECESSED	
Master box: 75pcs						

ALDO SQUARE

IN GROUND		1,7W 4000K 3000K	114.000.Z1L 114.000.Z1R		RECESSED	
Master box: 75pcs						

GARDEN CLASSIC

- 10 REVIVAL
- 32 GARDEN SMALL
- 48 GARDEN MEDIUM
- 68 GARDEN LARGE
- 84 HALF LANTERN
- 86 BOLLARD

GARDEN MODERN

- 92 BOLLARD
- 112 DOWNLIGHT
- 120 UP&DOWN
- 134 FLOODLIGHT
- 142 IN-GROUND
- 148 BRICKLIGHT
- 158 BULKHEAD
- 176 POST

SOLAR

- 184 SOLAR MODERN
- 192 SOLAR CLASSIC
- 194 LAMPS

CECI
IN-GROUND



MADE IN ITALY



1F2.000.U1K

CCT SETTABLE

2700 K 4000 K

SDCM <3



CECI 90 CCT LED VERSIONS					
LAMP	POWER	LUMINOUS FLUX (Φ TOTAL) UP TO	VOLTAGE RANGE	CCT SETTABLE	
GU10 LED	3,5W	366 lm	100-240V 50/60 Hz	4000K/2700K	=35W HALOGEN
GU10 LED	6W	615 lm	100-240V 50/60 Hz	4000K/2700K	=50W HALOGEN

AVAILABLE COLORS	
BODY (MOULDED COLOURS)	DIFFUSER
BLACK (A) GREY (L)	FROSTED (X) BLUE (U) GREEN (N) ORANGE (R)

CECI 90

	3,5W	1F1.000.U1K
	6W	1F1.000.L1K

CECI 90-2L

	3,5W	1F2.000.U1K
	6W	1F2.000.L1K

CECI 90-3L

	3,5W	1F3.000.U1K
	6W	1F3.000.L1K

CECI 90-SQ

	3,5W	1F4.000.U1K
	6W	1F4.000.L1K

Technical drawing showing dimensions: 92mm diameter, 127mm height, 85mm base width. Master box: 40pcs

- 10 REVIVAL
- 32 GARDEN SMALL
- 48 GARDEN MEDIUM
- 68 GARDEN LARGE
- 84 HALF LANTERN
- 86 BOLLARD
- 92 BOLLARD
- 112 DOWNLIGHT
- 120 UP&DOWN
- 134 FLOODLIGHT
- 142 IN-GROUND
- 148 BRICKLIGHT
- 158 BULKHEAD
- 176 POST
- 184 SOLAR MODERN
- 192 SOLAR CLASSIC
- 194 LAMPS

AVAILABLE COLORS

COVER (MOULDED COLOURS)

BLACK (A) GREY (L)

DIFFUSER

FROSTED (X)

BLUE (U) GREEN (N) ORANGE (R)

CE

IP67

UV

DOUBLE INSULATION CLASS

UNTREATED

ANTI-SHOCK

RECYCLABLE

CECI 120 LED VERSIONS					
LAMP	POWER	LUMINOUS FLUX (Φ TOTAL)	VOLTAGE RANGE	CCT SETTABLE	
	3W	410 lm	100-240V 50/60 Hz	6500K/4000K/3000K	40W INCANDESCENT

CECI 120

LED GX53 LAMP INCLUDED **3W** 2F1.000.G1K

Master box: **36pcs**

CECI 120-2L

LED GX53 LAMP INCLUDED **3W** 2F2.000.G1K

Master box: **36pcs**

CECI 120-3L

LED GX53 LAMP INCLUDED **3W** 2F3.000.G1K

Master box: **36pcs**

CECI 120-SQ

LED GX53 LAMP INCLUDED **3W** 2F4.000.G1K

Master box: **36pcs**

CECI 160 LED VERSIONS					
LAMP	POWER	LUMINOUS FLUX (Φ TOTAL)	VOLTAGE RANGE	CCT SETTABLE	
	10W	1290 lm	100-240V 50/60 Hz	6500K/4000K/3000K	100W INCANDESCENT

CECI 160

LED GX53 LAMP INCLUDED **10W** 3F1.000.D1K

Master box: **18pcs**

CECI 160-2L

LED GX53 LAMP INCLUDED **10W** 3F2.000.D1K

Master box: **18pcs**

CECI 160-3L

LED GX53 LAMP INCLUDED **10W** 3F3.000.D1K

Master box: **18pcs**

CECI 160-SQ

LED GX53 LAMP INCLUDED **10W** 3F4.000.D1K

Master box: **18pcs**

10 REVIVAL

32 GARDEN SMALL

48 GARDEN MEDIUM

68 GARDEN LARGE

84 HALF LANTERN

86 BOLLARD

92 BOLLARD

112 DOWNLIGHT

120 UP&DOWN

134 FLOODLIGHT

142 IN-GROUND

148 BRICKLIGHT

158 BULKHEAD

176 POST

184 SOLAR MODERN

192 SOLAR CLASSIC

194 LAMPS

NINA RANGE

BRICKLIGHT



MADE IN ITALY



6C1.000.J1K

CCT SETTABLE

2700 K 4000 K 6500 K

SDCM <6



NINA LED VERSIONS				
LAMP	POWER	LUMINOUS FLUX UP TO	VOLTAGE RANGE	CCT SETTABLE
R7s LED	3,5W	365 lm	100-240V 50/60 Hz	6500K/4000K/2700K
R7s LED	7,5W	790 lm	100-240V 50/60 Hz	6500K/4000K/2700K
R7s LED	10,5W	1160 lm	100-240V 50/60 Hz	6500K/4000K/2700K

AVAILABLE COLORS			
RESIN BODY (MOULDED COLOURS)			DIFFUSER
BLACK (A)	GREY (L)	WHITE (W)	OPAL (Y)

NINA 150

LED R7s LAMP INCLUDED **3,5W** 6C1.000.J1K

Master box: **50pcs**

NINA 190

LED R7s LAMP INCLUDED **7,5W** 7C1.000.K1K

Master box: **50pcs**

NINA 270

LED R7s LAMP INCLUDED **10,5W** 8C1.000.P1K

Master box: **30pcs**

- 10 REVIVAL
- 32 GARDEN SMALL
- 48 GARDEN MEDIUM
- 68 GARDEN LARGE
- 84 HALF LANTERN
- 86 BOLLARD
- 92 BOLLARD
- 112 DOWNLIGHT
- 120 UP&DOWN
- 134 FLOODLIGHT
- 142 IN-GROUND
- 148 BRICKLIGHT
- 158 BULKHEAD
- 176 POST
- 184 SOLAR MODERN
- 192 SOLAR CLASSIC
- 194 LAMPS

LORENZA RANGE

BRIKLIGHT



MADE IN ITALY



AS1.000.J1K

CCT SETTABLE

2700 K 4000 K 6500 K

SDCM <6



LORENZA LED VERSIONS				
LAMP	POWER	LUMINOUS FLUX UP TO	VOLTAGE RANGE	CCT SETTABLE
R7s LED	3,5W	365 lm	100-240V 50/60 Hz	6500K/4000K/2700K
R7s LED	7,5W	790 lm	100-240V 50/60 Hz	6500K/4000K/2700K
R7s LED	10,5W	1160 lm	100-240V 50/60 Hz	6500K/4000K/2700K

AVAILABLE COLORS			
RESIN BODY (MOULDED COLOURS)			DIFFUSER
BLACK (A)	GREY (L)	WHITE (W)	CLEAR (X)

LORENZA 150

CCT SET LED R7s LAMP INCLUDED **3,5W** AS1.000.J1K

Master box: **24pcs**

LORENZA 190

CCT SET LED R7s LAMP INCLUDED **7,5W** AS2.000.K1K

Master box: **24pcs**

LORENZA 270

CCT SET LED R7s LAMP INCLUDED **10,5W** AS3.000.P1K

Master box: **14pcs**

- 10 REVIVAL
- 32 GARDEN SMALL
- 48 GARDEN MEDIUM
- 68 GARDEN LARGE
- 84 HALF LANTERN
- 86 BOLLARD
- 92 BOLLARD
- 112 DOWNLIGHT
- 120 UP&DOWN
- 134 FLOODLIGHT
- 142 IN-GROUND
- 148 BRICKLIGHT
- 158 BULKHEAD
- 176 POST
- 184 SOLAR MODERN
- 192 SOLAR CLASSIC
- 194 LAMPS

LETI RANGE

BRICKLIGHT



MADE IN ITALY

2C1.000.G1K



CCT SETTABLE

3000 K 4000 K 6500 K

SDCM <6



BRICKLIGHT

LETI/EXTRALETI 100 ROUND

LETI/EXTRALETI 100 CCT LED VERSIONS					
LAMP	POWER	LUMINOUS FLUX (Φ TOTAL)	VOLTAGE RANGE	CCT SETTABLE	
	3W	410 lm	100-240V 50/60 Hz	6500K/4000K/3000K	=40W INCANDESCENT

AVAILABLE COLORS			
COVER (MOULDED COLOURS)			DIFFUSER
BLACK (A)	GREY (L)	WHITE (W)	OPAL (Y)

LETI 100 ROUND

LED GX53 LAMP INCLUDED 3W 2C1.000.G1K

Master box: **48pcs**

EXTRALETI 100 ROUND

LED GX53 LAMP INCLUDED 3W 2S1.000.G1K

Master box: **48pcs**

LETI 100 ROUND-GR

LED GX53 LAMP INCLUDED 3W 2C2.000.G1K

Master box: **48pcs**

EXTRALETI 100 ROUND-GR

LED GX53 LAMP INCLUDED 3W 2S2.000.G1K

Master box: **48pcs**

LETI 100 ROUND-EL

LED GX53 LAMP INCLUDED 3W 2C3.000.G1K

Master box: **48pcs**

EXTRALETI 100 ROUND-EL

LED GX53 LAMP INCLUDED 3W 2S3.000.G1K

Master box: **48pcs**

LETI 100 ROUND-ST

LED GX53 LAMP INCLUDED 3W 2C4.000.G1K

Master box: **48pcs**

EXTRALETI 100 ROUND-ST

LED GX53 LAMP INCLUDED 3W 2S4.000.G1K

Master box: **48pcs**

- 10 REVIVAL
- 32 GARDEN SMALL
- 48 GARDEN MEDIUM
- 68 GARDEN LARGE
- 84 HALF LANTERN
- 86 BOLLARD
- 92 BOLLARD
- 112 DOWNLIGHT
- 120 UP&DOWN
- 134 FLOODLIGHT
- 142 IN-GROUND
- 148 BRICKLIGHT
- 158 BULKHEAD
- 176 POST
- 184 SOLAR MODERN
- 192 SOLAR CLASSIC
- 194 LAMPS

LETI/EXTRALETI 100 SQUARE

BRICKLIGHT



LETI/EXTRALETI 100 LED VERSIONS					
LAMP	POWER	LUMINOUS FLUX (Φ TOTAL)	VOLTAGE RANGE	CCT SETTABLE	
	3W	410 lm	100-240V 50/60 Hz	6500K/4000K/3000K	40W INCANDESCENT

AVAILABLE COLORS	
COVER (MOULDED COLOURS)	DIFFUSER
BLACK (A) GREY (L) WHITE (W)	OPAL (Y)

LETI 100 SQUARE

CCT SET LED GX53 LAMP INCLUDED **3W** 3C1.000.G1K

Master box: **48pcs**

EXTRALETI 100 SQUARE

CCT SET LED GX53 LAMP INCLUDED **3W** 3S1.000.G1K

Master box: **48pcs**

LETI 100 SQUARE-GR

CCT SET LED GX53 LAMP INCLUDED **3W** 3C2.000.G1K

Master box: **48pcs**

EXTRALETI 100 SQUARE-GR

CCT SET LED GX53 LAMP INCLUDED **3W** 3S2.000.G1K

Master box: **48pcs**

LETI 100 SQUARE-EL

CCT SET LED GX53 LAMP INCLUDED **3W** 3C3.000.G1K

Master box: **48pcs**

EXTRALETI 100 SQUARE-EL

CCT SET LED GX53 LAMP INCLUDED **3W** 3S3.000.G1K

Master box: **48pcs**

LETI 100 SQUARE-ST

CCT SET LED GX53 LAMP INCLUDED **3W** 3C4.000.G1K

Master box: **48pcs**

EXTRALETI 100 SQUARE-ST

CCT SET LED GX53 LAMP INCLUDED **3W** 3S4.000.G1K

Master box: **48pcs**



BRICKLIGHT

LETI/EXTRALETI 200

LETI/EXTRALETI 200 CCT LED VERSIONS					
LAMP	POWER	LUMINOUS FLUX (Φ TOTAL)	VOLTAGE RANGE	CCT SETTABLE	
	3W	410 lm	100-240V 50/60 Hz	6500K/4000K/3000K	40W INCANDESCENT

AVAILABLE COLORS	
COVER (MOULDED COLOURS)	DIFFUSER
BLACK (A) GREY (L) WHITE (W)	OPAL (Y)

LETI 200

CCT SET LED GX53 LAMP INCLUDED **3W** 4C1.000.G1K

Master box: **36pcs**

EXTRALETI 200

CCT SET LED GX53 LAMP INCLUDED **3W** 4S1.000.G1K

Master box: **36pcs**

LETI 200-GL

CCT SET LED GX53 LAMP INCLUDED **3W** 4C2.000.G1K

Master box: **36pcs**

EXTRALETI 200-GL

CCT SET LED GX53 LAMP INCLUDED **3W** 4S2.000.G1K

Master box: **36pcs**

LETI 200-RS

CCT SET LED GX53 LAMP INCLUDED **3W** 4C3.000.G1K

Master box: **36pcs**

EXTRALETI 200-RS

CCT SET LED GX53 LAMP INCLUDED **3W** 4S3.000.G1K

Master box: **36pcs**

LETI 200-HS

CCT SET LED GX53 LAMP INCLUDED **3W** 4C4.000.G1K

Master box: **36pcs**

EXTRALETI 200-HS

CCT SET LED GX53 LAMP INCLUDED **3W** 4S4.000.G1K

Master box: **36pcs**

LETI 200-VP

CCT SET LED GX53 LAMP INCLUDED **3W** 4C5.000.G1K

Master box: **36pcs**

EXTRALETI 200-VP

CCT SET LED GX53 LAMP INCLUDED **3W** 4S5.000.G1K

Master box: **36pcs**

- 10 REVIVAL
- 32 GARDEN SMALL
- 48 GARDEN MEDIUM
- 68 GARDEN LARGE
- 84 HALF LANTERN
- 86 BOLLARD
- 92 BOLLARD
- 112 DOWNLIGHT
- 120 UP&DOWN
- 134 FLOODLIGHT
- 142 IN-GROUND
- 148 BRICKLIGHT
- 158 BULKHEAD
- 176 POST
- 184 SOLAR MODERN
- 192 SOLAR CLASSIC
- 194 LAMPS

LETI 300/EXTRALETI 300

BRICKLIGHT



MADE IN ITALY



5S1.000.G2K

NEW SLIMMER BODY VERSION

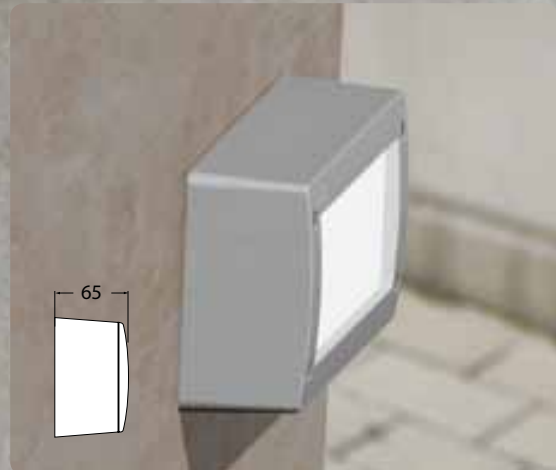

CCT SETTABLE

3000 K 4000 K 6500 K

SDCM <6



LETI/EXTRALETI 300

LETI/EXTRALETI 300 LED VERSIONS					
LAMP	POWER	LUMINOUS FLUX (Φ TOTAL)	VOLTAGE RANGE	CCT SETTABLE	
2x GX53	2x 3W 6W	820 lm	100-240V 50/60 Hz	6500K/4000K/3000K	=75W INCANDESCENT

AVAILABLE COLORS			
COVER (MOULDED COLOURS)			DIFFUSER
BLACK (A)	GREY (L)	WHITE (W)	OPAL (Y)

LETI 300

CCT SET LED GX53 LAMP INCLUDED

2x3W 6W 5C1.000.G2K

E27 5C1.000.E27

Master box: **24pcs**

EXTRALETI 300

CCT SET LED GX53 LAMP INCLUDED

2x3W 6W 5S1.000.G2K

Master box: **20pcs**

LETI 300-GL

CCT SET LED GX53 LAMP INCLUDED

2x3W 6W 5C2.000.G2K

E27 5C2.000.E27

Master box: **24pcs**

EXTRALETI 300-GL

CCT SET LED GX53 LAMP INCLUDED

2x3W 6W 5S2.000.G2K

Master box: **20pcs**

LETI 300-RS

CCT SET LED GX53 LAMP INCLUDED

2x3W 6W 5C3.000.G2K

E27 5C3.000.E27

Master box: **24pcs**

EXTRALETI 300-RS

CCT SET LED GX53 LAMP INCLUDED

2x3W 6W 5S3.000.G2K

Master box: **20pcs**

LETI 300-HS

CCT SET LED GX53 LAMP INCLUDED

2x3W 6W 5C4.000.G2K

E27 5C4.000.E27

Master box: **24pcs**

EXTRALETI 300-HS

CCT SET LED GX53 LAMP INCLUDED

2x3W 6W 5S4.000.G2K

Master box: **20pcs**

LETI 300-VP

CCT SET LED GX53 LAMP INCLUDED

2x3W 6W 5C5.000.G2K

E27 5C5.000.E27

Master box: **24pcs**

EXTRALETI 300-VP

CCT SET LED GX53 LAMP INCLUDED

2x3W 6W 5S5.000.G2K

Master box: **20pcs**

- 10 REVIVAL
- 32 GARDEN SMALL
- 48 GARDEN MEDIUM
- 68 GARDEN LARGE
- 84 HALF LANTERN
- 86 BOLLARD
- 92 BOLLARD
- 112 DOWNLIGHT
- 120 UP&DOWN
- 134 FLOODLIGHT
- 142 IN-GROUND
- 148 BRICKLIGHT
- 158 BULKHEAD
- 176 POST
- 184 SOLAR MODERN
- 192 SOLAR CLASSIC
- 194 LAMPS

BERTINA

BULKHEAD

Ø200 Ø275 Ø350
 BERTINA BERTA UMBERTA



UV UNTREATED ANTISHOCK RECYCLABLE CE CB IEC60746-2 SCHEME IP66 CLASS II DOUBLE INSULATION

MADE IN ITALY



1B1.000





NO SCREWS AT SIGHT

CCT SETTABLE

3000 K 4000 K 6500 K

SDCM <6



BERTINA CCT LED VERSIONS					
LAMP	POWER	LUMINOUS FLUX (Φ TOTAL)	VOLTAGE RANGE	CCT SETTABLE	
	3W	410 lm	100-240V 50/60 Hz	6500K/4000K/3000K	=40W INCANDESCENT 
	10W	1290 lm	100-240V 50/60 Hz	6500K/4000K/3000K	=100W INCANDESCENT 

AVAILABLE COLORS

RESIN BODY (MOULDED COLOURS)

BLACK (A) GREY (L) WHITE (W)

DIFFUSER OPAL (Y)



BERTINA

	3W	1B1.000.G1K
	10W	1B1.000.D1K



Master box: **45pcs**

AVAILABLE VERSIONS SUPPLIED FULLY PRE-WIRED

GX53 LED-CCT SETTABLE



3W

10W

GARDEN CLASSIC

- 10 REVIVAL
- 32 GARDEN SMALL
- 48 GARDEN MEDIUM
- 68 GARDEN LARGE
- 84 HALF LANTERN
- 86 BOLLARD
- 92 BOLLARD
- 112 DOWNLIGHT
- 120 UP&DOWN
- 134 FLOODLIGHT
- 142 IN-GROUND
- 148 BRICKLIGHT
- 158 BULKHEAD
- 176 POST

SOLAR

- 184 SOLAR MODERN
- 192 SOLAR CLASSIC
- 194 LAMPS

BERTA

BULKHEAD



NO SCREWS AT SIGHT

1B2.000



CCT SETTABLE

SDCM <6

2700 K 4000 K 6500 K

SMART PACK AVAILABLE

SUPPLIED FULLY PRE-WIRED



BERTA CCT LED VERSIONS					
LAMP	POWER	LUMINOUS FLUX (Φ TOTAL)	VOLTAGE RANGE	CCT SETTABLE	
	11,3W	1510 lm	100-240V 50/60 Hz	6500K/4000K/2700K	=100W INCANDESCENT
	17W	2350 lm	100-240V 50/60 Hz	6500K/4000K/2700K	=150W INCANDESCENT

AVAILABLE COLORS			
RESIN BODY (MOULDED COLOURS)			DIFFUSER
BLACK (A)	GREY (L)	WHITE (W)	OPAL (Y)

BERTA		
E27	2B2.000.P27	SMART PACK
E27	1B2.000.P27	SINGLE BOX
11,3W LED	1B2.000.B1K	
17W LED	1B2.000.E1K	

CCT SET LED GX53 LAMP INCLUDED

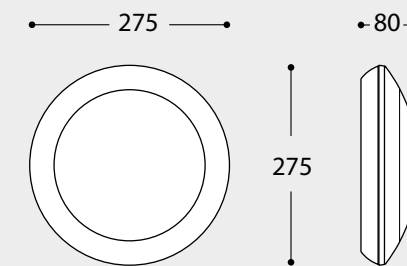

Master box: **16 pcs**

BERTA - AVAILABLE VERSIONS

BERTA E27 SINGLE BOX	BERTA E27 SMART PACK
cbm: 0,19 Master box: 16 pcs	<p>SAVE 21% VOLUME</p> <ul style="list-style-type: none"> ✓ Save 21% volume ✓ ECO-friendly packaging ✓ Film wrapped items <p>cbm: 0,15 Master box: 16 pcs</p>

GARDEN CLASSIC

- 10 REVIVAL
- 32 GARDEN SMALL
- 48 GARDEN MEDIUM
- 68 GARDEN LARGE
- 84 HALF LANTERN
- 86 BOLLARD

GARDEN MODERN

- 92 BOLLARD
- 112 DOWNLIGHT
- 120 UP&DOWN
- 134 FLOODLIGHT
- 142 IN-GROUND
- 148 BRICKLIGHT
- 158 BULKHEAD
- 176 POST

SOLAR

- 184 SOLAR MODERN
- 192 SOLAR CLASSIC
- 194 LAMPS

UMBERTA BULKHEAD



MADE IN ITALY

1B3.000

NO SCREWS AT SIGHT



CCT SETTABLE

2700 K 4000 K 6500 K

SDCM <6

SMART PACK AVAILABLE

SUPPLIED FULLY PRE-WIRED



UMBERTA CCT LED VERSIONS					
LAMP	POWER	LUMINOUS FLUX (Φ TOTAL)	VOLTAGE RANGE	CCT SETTABLE	
	11,3W	1510 lm	100-240V 50/60 Hz	6500K/4000K/2700K	=100W INCANDESCENT
	17W	2350 lm	100-240V 50/60 Hz	6500K/4000K/2700K	=150W INCANDESCENT

AVAILABLE COLORS			
RESIN BODY (MOULDED COLOURS)			DIFFUSER
BLACK (A)	GREY (L)	WHITE (W)	OPAL (Y)

UMBERTA

E27	2B3.000.E27	SMART PACK
2x E27	2B3.000.E28	SMART PACK
E27	1B3.000.E27	SINGLE BOX
2x E27	1B3.000.E28	SINGLE BOX
11,3W LED	1B3.000.B1K	
17W LED	1B3.000.E1K	

Standard Master box: **12pcs**
Smart Pack Master box: **16pcs**

UMBERTA - AVAILABLE VERSIONS

UMBERTA E27 SINGLE BOX	UMBERTA E27 SMART PACK
cbm: 0,19 Master box: 12 pcs	<p>SAVE 20% VOLUME</p> <ul style="list-style-type: none"> Save 20% volume ECO-friendly packaging Film wrapped items
	cbm: 0,21 Master box: 16 pcs

- 10 REVIVAL
- 32 GARDEN SMALL
- 48 GARDEN MEDIUM
- 68 GARDEN LARGE
- 84 HALF LANTERN
- 86 BOLLARD
- 92 BOLLARD
- 112 DOWNLIGHT
- 120 UP&DOWN
- 134 FLOODLIGHT
- 142 IN-GROUND
- 148 BRICKLIGHT
- 158 BULKHEAD
- 176 POST
- 184 SOLAR MODERN
- 192 SOLAR CLASSIC
- 194 LAMPS

UMBERTA-EMERGENCY

BULKHEAD



EMERGENCY

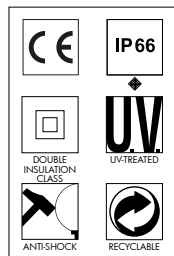
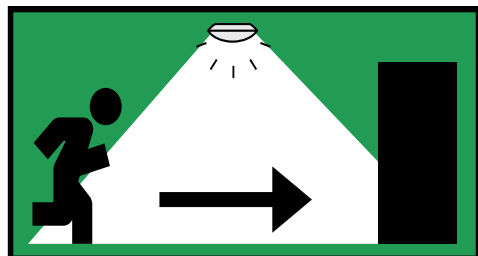

UMBERTA EMERGENCY - LED VERSIONS					
EMERGENCY KIT	MODE	POWER	LUMINOUS FLUX (Φ TOTAL) UP TO	VOLTAGE RANGE	COLOUR TEMPERATURE
	NORMAL	15W	2000 lm	220-240V 50/60 Hz	4000K
	EMERGENCY (min 3 hours)	2,4W	250 lm	220-240V 50/60 Hz	4000K

UMBERTA LED MAINTAINED EMERGENCY

LED 4000K 1B3.000.EM1

PRODUCT TYPE	Wall and Ceiling bulkhead with Emergency kit
OPERATING VOLTAGE	220~240 vAC
LUMINOUS FLUX & POWER	2000 lumen (Normal mode), 15W 250 lumen (Emergency mode), 2.4W
LED TYPE	Edison SMD 2835, 4000 K
CRI	>80Ra
PF (POWER FACTOR)	>0.95
BEAM ANGLE	120°
OPERATING TEMPERATURE	0~50°C
BATTERY	Ni-MH, BK370Ah3.6V, Panasonic (3.5Ah, 3.6V)
BATTERY OPERATING TIME	min 3 hours (250 lumen)
BATTERY CHARGING TIME	24 hours
Drivers Standards	EN 61347-1, EN 61347-2-7, EN 61347-2-13, EN 62384, EN 60598-2-22 EN 55015, EN61547, EN 61000-3-2, EN 61000-3-3
Battery Standards	EN 5501-1, EN 61000, EN 55014-2

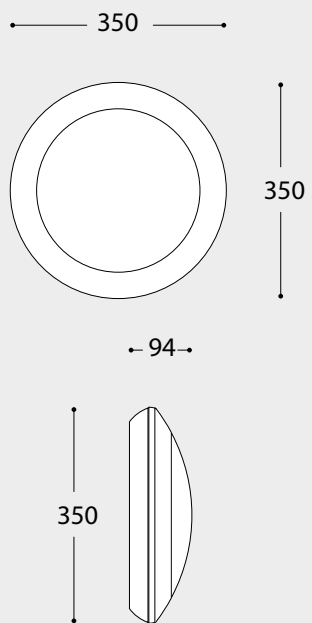

HOW IT WORKS

In case of blackout, the emergency kit turns on. The Bulkhead switches from Normal mode to Emergency mode and keeps on working.



Provided with built-in test button to check battery status.



Green Led: identifies the emergency light and shows that the system is operating correctly.

BULKHEAD



UMBERTA - SENSOR

SENSOR

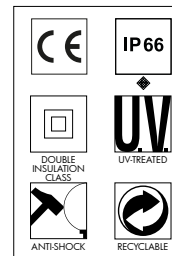
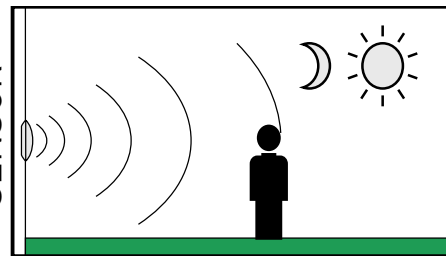

UMBERTA CCT LED VERSIONS					
LAMP	POWER	LUMINOUS FLUX (Φ TOTAL)	VOLTAGE RANGE	CCT SETTABLE	
	11,3W	1510 lm	100-240V 50/60 Hz	6500K/4000K/2700K	=100W INCANDESCENT
	17W	2350 lm	100-240V 50/60 Hz	6500K/4000K/2700K	=150W INCANDESCENT

UMBERTA MOTION & DAYLIGHT SENSOR

E27 WITH SENSOR)))	1B3.000.E57
2x E27 WITH SENSOR)))	1B3.000.E58
11,3W LED GX53 WITH SENSOR)))	1B3.000.BSK
17W LED GX53 WITH SENSOR)))	1B3.000.ESK

Product Type	Wall and Ceiling bulkhead with Motion&Daylight sensor
Sensor operating voltage	220~240 vAC (120v version available on demand)
Version	GX53 LED, E27, 2xE27
Sensor Operating Temperature	-10° +60°C
Detection angle	30° - 150°
Fields of detection	1 - up to 5 mt (adjustable)

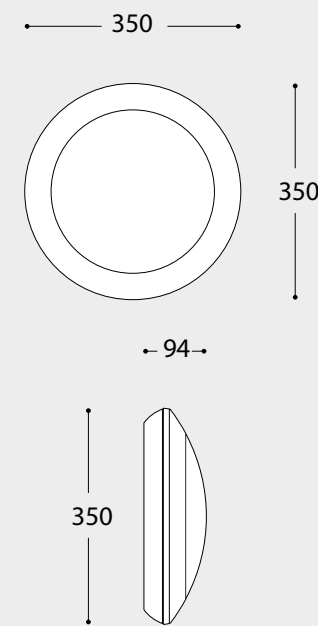

10	REVIVAL
32	GARDEN SMALL
48	GARDEN MEDIUM
68	GARDEN LARGE
84	HALF LANTERN
86	BOLLARD
92	BOLLARD
112	DOWNLIGHT
120	UP&DOWN
134	FLOODLIGHT
142	IN-GROUND
148	BRICKLIGHT
158	BULKHEAD
176	POST
184	SOLAR MODERN
192	SOLAR CLASSIC
194	LAMPS

GELMI BULKHEAD



1G3.000

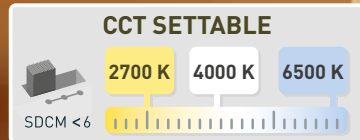

LED BULKHEAD GX53						AVAILABLE COLORS			
LAMP	POWER	LUMINOUS FLUX (Φ TOTAL)	VOLTAGE RANGE	CCT SETTABLE		RESIN BODY (MOULDED COLOURS)			DIFFUSER
	11,3W	1510 lm	100-240V 50/60 Hz	6500K/4000K/2700K	=100W INCANDESCENT	BLACK (A)	GREY (L)	WHITE (W)	OPAL (Y)
	17W	2350 lm	100-240V 50/60 Hz	6500K/4000K/2700K	=150W INCANDESCENT				

GELMI

E27	1G3.000.E27
GX53 LED 11,3W	1G3.000.B1K
GX53 LED 17W	1G3.000.E1K

CCT SET LED GX53 LAMP INCLUDED

Master box: **16pcs**

GELMI-EL

E27	2G3.000.E27
GX53 LED 11,3W	2G3.000.B1K
GX53 LED 17W	2G3.000.E1K

CCT SET LED GX53 LAMP INCLUDED

Master box: **16pcs**

GELMI-GR

E27	3G3.000.E27
GX53 LED 11,3W	3G3.000.B1K
GX53 LED 17W	3G3.000.E1K

CCT SET LED GX53 LAMP INCLUDED

Master box: **16pcs**

GARDEN CLASSIC

- 10 REVIVAL
- 32 GARDEN SMALL
- 48 GARDEN MEDIUM
- 68 GARDEN LARGE
- 84 HALF LANTERN
- 86 BOLLARD
- 92 BOLLARD
- 112 DOWNLIGHT
- 120 UP&DOWN

GARDEN MODERN

- 134 FLOODLIGHT
- 142 IN-GROUND
- 148 BRICKLIGHT
- 158 BULKHEAD
- 176 POST

SOLAR

- 184 SOLAR MODERN
- 192 SOLAR CLASSIC
- 194 LAMPS

DANZI
BULKHEAD



1D3.000



SUPPLIED FULLY PRE-WIRED

GX53 LED

E27

E27 + SENSOR

WITH SENSOR))
220-240V
(.E57)



LED BULKHEAD GX53					
LAMP	POWER	LUMINOUS FLUX (Φ TOTAL)	VOLTAGE RANGE	CCT SETTABLE	
	11,3W	1510 lm	100-240V 50/60 Hz	6500K/4000K/2700K	=100W INCANDESCENT
	17W	2350 lm	100-240V 50/60 Hz	6500K/4000K/2700K	=150W INCANDESCENT

AVAILABLE COLORS			
RESIN BODY (MOULDED COLOURS)			DIFFUSER
BLACK (A)	GREY (L)	WHITE (W)	OPAL (Y)

DANZI	
	<p>CCT SET LED GX53 LAMP INCLUDED</p>
E27	1D3.000.E27
GX53 LED 11,3W	1D3.000.B1K
GX53 LED 17W	1D3.000.E1K
Master box: 16pcs	

DANZI-VE	
	<p>CCT SET LED GX53 LAMP INCLUDED</p>
E27	2D3.000.E27
GX53 LED 11,3W	2D3.000.B1K
GX53 LED 17W	2D3.000.E1K
Master box: 16pcs	

DANZI-GR	
	<p>CCT SET LED GX53 LAMP INCLUDED</p>
E27	3D3.000.E27
GX53 LED 11,3W	3D3.000.B1K
GX53 LED 17W	3D3.000.E1K
Master box: 16pcs	

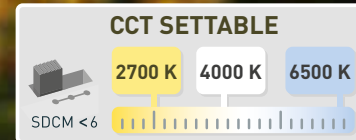

GARDEN CLASSIC

- 10 REVIVAL
- 32 GARDEN SMALL
- 48 GARDEN MEDIUM
- 68 GARDEN LARGE
- 84 HALF LANTERN
- 86 BOLLARD
- 92 BOLLARD
- 112 DOWNLIGHT
- 120 UP&DOWN

GARDEN MODERN

- 134 FLOODLIGHT
- 142 IN-GROUND
- 148 BRICKLIGHT
- 158 BULKHEAD
- 176 POST

SOLAR

- 184 SOLAR MODERN
- 192 SOLAR CLASSIC
- 194 LAMPS

STUCCHI BULKHEAD

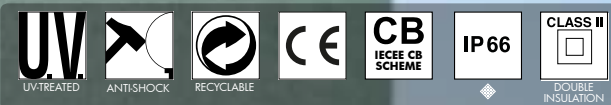

MADE IN ITALY



1U3.000

CCT SETTABLE

SDCM <6

2700 K 4000 K 6500 K

SUPPLIED FULLY PRE-WIRED

GX53 LED	E27	E27 + SENSOR

WITH SENSOR)))
220-240V
(.ES7)

BACKLIT COLOURS AVAILABLE

*To order the backlit version of our bulkhead, the following suffixes have to be added at the end of the code.

CLEAR .CL1	PINK .PK1	BLUE .BU1	GREEN .GN1	ORANGE .OR1



LED BULKHEAD GX53

LAMP	POWER	LUMINOUS FLUX (Φ TOTAL)	VOLTAGE RANGE	CCT SETTABLE	
	11,3W	1510 lm	100-240V 50/60 Hz	6500K/4000K/2700K	=100W INCANDESCENT
	17W	2350 lm	100-240V 50/60 Hz	6500K/4000K/2700K	=150W INCANDESCENT

AVAILABLE COLORS

RESIN BODY (MOULDED COLOURS)			DIFFUSER
BLACK (A)	GREY (L)	WHITE (W)	OPAL (Y)

STUCCHI

CCT SET LED GX53 LAMP INCLUDED

E27	1U3.000.E27
GX53 LED 11,3W	1U3.000.B1K
GX53 LED 17W	1U3.000.E1K

BACKLIT COLOURS VERSION

*To order the backlit version of our bulkhead, the following suffixes have to be added at the end of the code.

CLEAR .CL1	PINK .PK1	BLUE .BU1	GREEN .GN1	ORANGE .OR1

Master box: **16pcs**

CECCHI

CCT SET LED GX53 LAMP INCLUDED

E27	1H3.000.E27
GX53 LED 11,3W	1H3.000.B1K
GX53 LED 17W	1H3.000.E1K

BACKLIT COLOURS VERSION

*To order the backlit version of our bulkhead, the following suffixes have to be added at the end of the code.

CLEAR .CL1	PINK .PK1	BLUE .BU1	GREEN .GN1	ORANGE .OR1

Master box: **16pcs**

RITA

CCT SET LED GX53 LAMP INCLUDED

E27	1T3.000.E27
GX53 LED 11,3W	1T3.000.B1K
GX53 LED 17W	1T3.000.E1K

MOULDED COLOURS

BLACK (A)	WHITE (W)	ANTIQUE GREEN (V)	ANTIQUE BRONZE (B)

PAINTED COLOURS

*To order the painted colour version of RITA, the following suffixes have to be added at the end of the code.

Master box: **12pcs**

10	REVIVAL
32	GARDEN SMALL
48	GARDEN MEDIUM
68	GARDEN LARGE
84	HALF LANTERN
86	BOLLARD
92	BOLLARD
112	DOWNLIGHT
120	UP&DOWN
134	FLOODLIGHT
142	IN-GROUND
148	BRICKLIGHT
158	BULKHEAD
176	POST
184	SOLAR MODERN
192	SOLAR CLASSIC
194	LAMPS

LUCIA BULKHEAD



1R3.000

CCT SETTABLE

2700 K 4000 K 6500 K

SDCM <6

BACKLIT COLOURS AVAILABLE

*To order the backlit version of our bulkhead, the following suffixes have to be added at the end of the code.

CLEAR .CL1 PINK .PK1 BLUE .BU1 GREEN .GN1 ORANGE .OR1

SUPPLIED FULLY PRE-WIRED

GX53 LED E27 E27 + SENSOR

WITH SENSOR)))
220-240V
(.ES7)

SMART PACK AVAILABLE

NEW SMART PACK *

- Save 21% volume
- ECO-friendly packaging
- Film wrapped items

SAVE 21% VOLUME

cbm: 0,15
Master box: 16 pcs



LED BULKHEAD GX53					
LAMP	POWER	LUMINOUS FLUX (Φ TOTAL)	VOLTAGE RANGE	CCT SETTABLE	
	11,3W	1510 lm	100-240V 50/60 Hz	6500K/4000K/2700K	=100W INCANDESCENT
	17W	2350 lm	100-240V 50/60 Hz	6500K/4000K/2700K	=150W INCANDESCENT

AVAILABLE COLORS			
RESIN BODY (MOULDED COLOURS)			DIFFUSER
BLACK (A)	GREY (L)	WHITE (W)	OPAL (Y)

LUCIA

E27	1R3.000.E27
GX53 LED 11,3W	1R3.000.B1K
GX53 LED 17W	1R3.000.E1K

NEW SMART PACK *

E27 1R4.000.E27

REMI/LUCIA

E27	1R3.602.E27
GX53 LED 11,3W	1R3.602.B1K
GX53 LED 17W	1R3.602.E1K

cbm: 0,19
Master box: 16pcs

LUCIA-EL

E27	2R3.000.E27
GX53 LED 11,3W	2R3.000.B1K
GX53 LED 17W	2R3.000.E1K

NEW SMART PACK *

E27 2R4.000.E27

REMI/LUCIA-EL

E27	2R3.602.E27
GX53 LED 11,3W	2R3.602.B1K
GX53 LED 17W	2R3.602.E1K

cbm: 0,19
Master box: 16pcs

LUCIA-GD

E27	3R3.000.E27
GX53 LED 11,3W	3R3.000.B1K
GX53 LED 17W	3R3.000.E1K

NEW SMART PACK *

E27 3R4.000.E27

REMI/LUCIA-GD

E27	3R3.602.E27
GX53 LED 11,3W	3R3.602.B1K
GX53 LED 17W	3R3.602.E1K

cbm: 0,19
Master box: 16pcs

GARDEN CLASSIC

10 REVIVAL

32 GARDEN SMALL

48 GARDEN MEDIUM

68 GARDEN LARGE

84 HALF LANTERN

86 BOLLARD

92 BOLLARD

112 DOWNLIGHT

120 UP&DOWN

GARDEN MODERN

134 FLOODLIGHT

142 IN-GROUND

148 BRICKLIGHT

158 BULKHEAD

176 POST

SOLAR

184 SOLAR MODERN

192 SOLAR CLASSIC

194 LAMPS

MADDI BULKHEAD



MADE IN ITALY



1V3.000

CCT SETTABLE

SDCM <6

2700 K 4000 K 6500 K

BACKLIT COLOURS AVAILABLE

*To order the backlit version of our bulkhead, the following suffixes have to be added at the end of the code.

CLEAR .CL1 PINK .PK1 BLUE .BU1 GREEN .GN1 ORANGE .OR1

SUPPLIED FULLY PRE-WIRED

GX53 LED E27 E27 + SENSOR

WITH SENSOR))) 220-240V (.E57)

SMART PACK AVAILABLE

NEW SMART PACK *

- Save 21% volume
- ECO-friendly packaging
- Film wrapped items

SAVE 21% VOLUME

cbm: 0,15 Master box: 16 pcs



LED BULKHEAD GX53					
LAMP	POWER	LUMINOUS FLUX (Φ TOTAL)	VOLTAGE RANGE	CCT SETTABLE	
	11,3W	1510 lm	100-240V 50/60 Hz	6500K/4000K/2700K	=100W INCANDESCENT
	17W	2350 lm	100-240V 50/60 Hz	6500K/4000K/2700K	=150W INCANDESCENT

AVAILABLE COLORS			
RESIN BODY (MOULDED COLOURS)			DIFFUSER
BLACK (A)	GREY (L)	WHITE (W)	OPAL (Y)

MADDI

E27 1V3.000.E27

GX53 LED 11,3W 1V3.000.B1K

GX53 LED 17W 1V3.000.E1K

NEW SMART PACK *

E27 1V4.000.E27

CCT SET LED GX53 LAMP INCLUDED

MADDI-VE

E27 2V3.000.E27

GX53 LED 11,3W 2V3.000.B1K

GX53 LED 17W 2V3.000.E1K

NEW SMART PACK *

E27 2V4.000.E27

CCT SET LED GX53 LAMP INCLUDED

REMI/MADDI

E27 1V3.602.E27

GX53 LED 11,3W 1V3.602.B1K

GX53 LED 17W 1V3.602.E1K

Master box: 16pcs

cbm: 0,19

REMI/MADDI-VE

E27 2V3.602.E27

GX53 LED 11,3W 2V3.602.B1K

GX53 LED 17W 2V3.602.E1K

Master box: 16pcs

cbm: 0,19

MADDI-HL

E27 3V3.000.E27

GX53 LED 11,3W 3V3.000.B1K

GX53 LED 17W 3V3.000.E1K

NEW SMART PACK *

E27 3V4.000.E27

CCT SET LED GX53 LAMP INCLUDED

MADDI-HL

E27 3V3.000.E27

GX53 LED 11,3W 3V3.000.B1K

GX53 LED 17W 3V3.000.E1K

Master box: 16pcs

cbm: 0,19

REMI/MADDI-HL

E27 3V3.602.E27

GX53 LED 11,3W 3V3.602.B1K

GX53 LED 17W 3V3.602.E1K

Master box: 16pcs

- 10 REVIVAL
- 32 GARDEN SMALL
- 48 GARDEN MEDIUM
- 68 GARDEN LARGE
- 84 HALF LANTERN
- 86 BOLLARD
- 92 BOLLARD
- 112 DOWNLIGHT
- 120 UP&DOWN
- 134 FLOODLIGHT
- 142 IN-GROUND
- 148 BRICKLIGHT
- 154 BULKHEAD
- 176 POST
- 184 SOLAR MODERN
- 192 SOLAR CLASSIC
- 194 LAMPS

GIORGIO / ROSA

POST

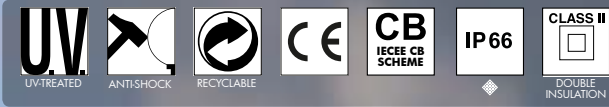

MADE IN ITALY



AVAILABLE COLORS			AVAILABLE VERSIONS		
RESIN BODY (MOULDED COLOURS)			GX53 LED		
BLACK (A)	GREY (L)	WHITE (W)	OPAL (Y)	GX53 LED	4x GX53
					2x E27



POST EKTOR / GIORGIO - ROSA

GIORGIO LED VERSIONS					
LAMP	POWER	LUMINOUS FLUX (Φ TOTAL)	VOLTAGE RANGE	CCT SETTABLE	
	11,3W	1510lm	100-240V 50/60 Hz	6500K/4000K/3000K	=100W INCANDESCENT
	17W	2350 lm	100-240V 50/60 Hz	6500K/4000K/3000K	=150W INCANDESCENT
4x	4x10W 40W	5160 lm	100-240V 50/60 Hz	6500K/4000K/3000K	=100W HQI-SON

ROSA LED VERSIONS					
LAMP	POWER	LUMINOUS FLUX (Φ TOTAL)	VOLTAGE RANGE	CCT SETTABLE	
	2x11,3W 22W	3020 lm	100-240V 50/60 Hz	6500K/4000K/3000K	=2x100W INCANDESCENT
	2x17W 36W	4700lm	100-240V 50/60 Hz	6500K/4000K/3000K	=2x150W INCANDESCENT
	2x40W 80W	10320 lm	100-240V 50/60 Hz	6500K/4000K/3000K	=2x100W HQI-SON

EKTOR 2500 /GIORGIO	
E27	4P2.361.G10.E28
11,3W	4P1.361.G10.B1K
17W	4P1.361.G10.E1K
4x10W 40W	4P2.361.G10.D4K

EKTOR 2500 /ROSA	
2x E27	4P2.361.G20.E28
2x1,3W	4P1.361.G20.B1K
2x17W	4P1.361.G20.E1K
2x40W	4P2.361.G20.D4K

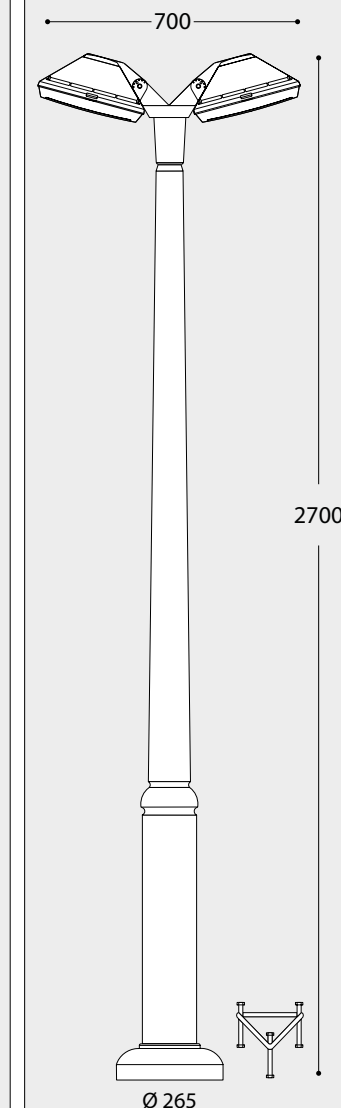
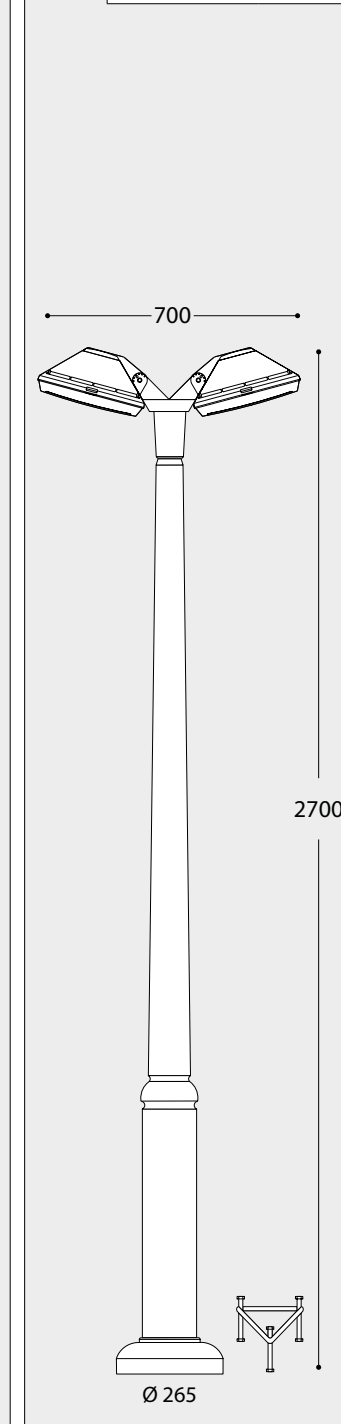
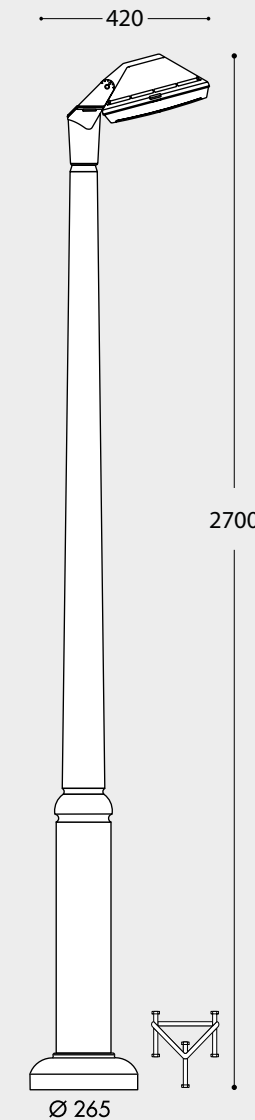

MADE IN ITALY

- 10 REVIVAL
- 32 GARDEN SMALL
- 48 GARDEN MEDIUM
- 68 GARDEN LARGE
- 84 HALF LANTERN
- 86 BOLLARD
- 92 BOLLARD
- 112 DOWNLIGHT
- 120 UP&DOWN
- 134 FLOODLIGHT
- 142 IN-GROUND
- 148 BRICKLIGHT
- 158 BULKHEAD
- 176 POST
- 184 SOLAR MODERN
- 192 SOLAR CLASSIC
- 194 LAMPS

BEPPE 400/VIVI 400

POST



MADE IN ITALY



NEW HIGH POWER LED

INDOOR & OUTDOOR USE

+80°C
-30°C 90% HUMIDITY

VOLTAGE SURGE RESISTANT

30W (3620 lm)
50W (6550 lm)

More details at page 196



POST EKTOR / BEPPE-VIVI 400

BEPPE-VIVI 400 HIGH POWER LED					
LAMP	POWER	LUMINOUS FLUX UP TO	VOLTAGE RANGE	COLOUR TEMPERATURE	
HIGH POWER LED E27	30W	3620 lm	100-240V 50/60 Hz	3000K/ 4000K	=70W HQI-SON
HIGH POWER LED E27	50W	6550 lm	100-240V 50/60 Hz	4000K 3000K	=70W HQI-SON

AVAILABLE COLORS	
RESIN BODY (MOULDED COLOURS)	DIFFUSER
BLACK (A) GREY (L) WHITE (W)	CLEAR (X) OPAL (Y)

EKTOR 2500 / BEPPE400		
30W LED	CCT SET	P50.361.Q1K
50W LED	4000K	P50.361.H1L
	3000K	P50.361.H1R

EKTOR 2500 MIDIPILAR / VIVI400 1L		
30W LED	CCT SET	V50.361.A10.Q1K
50W LED	4000K	V50.361.A10.H1L
	3000K	V50.361.A10.H1R

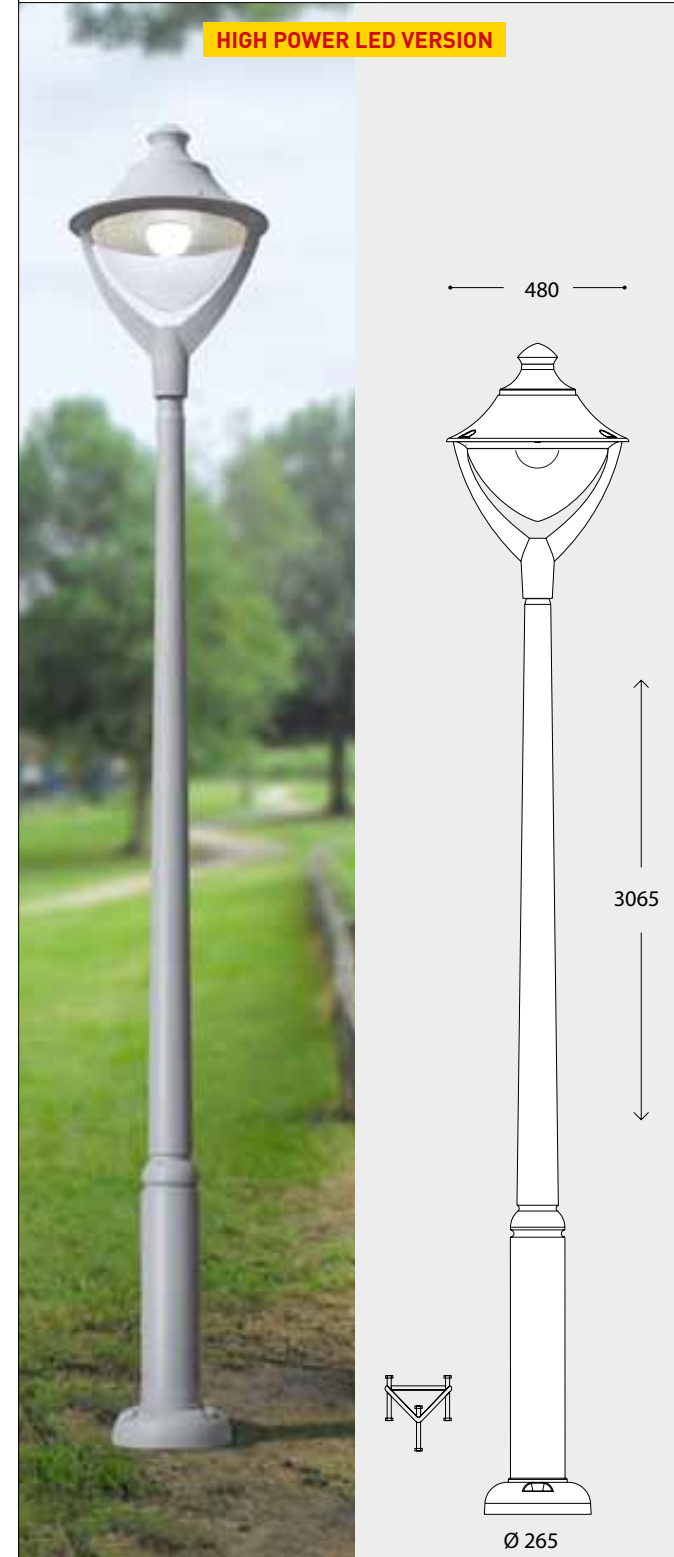

MADE IN ITALY

- 10 REVIVAL
- 32 GARDEN SMALL
- 48 GARDEN MEDIUM
- 68 GARDEN LARGE
- 84 HALF LANTERN
- 86 BOLLARD
- 92 BOLLARD
- 112 DOWNLIGHT
- 120 UP&DOWN
- 134 FLOODLIGHT
- 142 IN-GROUND
- 148 BRICKLIGHT
- 158 BULKHEAD
- 176 POST
- 184 SOLAR MODERN
- 192 SOLAR CLASSIC
- 194 LAMPS

FORTUNATO
for details see pag.187



BISSO/ROSETTA
for details see pag. 193

FELICE 200
for details sWW.189



FELICE 400
for details see pag.189



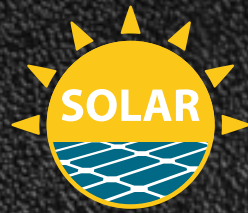

fumagalli®
s i n c e 1 9 7 3



PROMO GARDEN 2024 - SOLAR RANGE

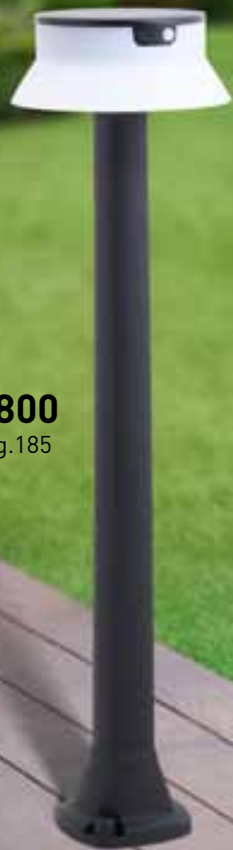

JOSEPHA 800
for details see pag.185



FIORINA
for details see pag.187



MINILOT/ROSETTA
for details see pag.193



JOSEPHA 160
for details see pag.185



TÜV CERTIFIED LED MODULES



SWITCH FOR ON/OFF and BATTERY ACTIVATION

SOLAR PANEL
 • Panel 2W/5V
 • Monocrystalline
 • High resistant tempered glass



MATERIAL
 • PC material suitable for outdoor use
 • UV rays stabilized
 • Anti shock



REPLACEABLE BATTERY
 • Quick and easy battery replacement
 • LiFePO4 IFR 26650 3,4Ah-3,2V
 • No risk of explosion



PIR SENSOR
 • Detection angle 120°
 • Fields of detection up to 5m
 • Active for 25 sec.



LENS
 • Frosted color lens reducing dazzle.
 • Made of UV rays stabilized resin material to avoid yellowing process.
 • Very compact and slim design for a better light distribution and for improving the light efficiency.

LED
 • Power absorption of the led plate 2,7W (at 100% light)
 • LED chips connected by pure **gold wires** able to withstand at the highest and lowest temperatures and granting a **lumens maintenance factor > 80%**.
 • SMD 2835 LED.
 • 4000K CRI>80



NEW VERSION

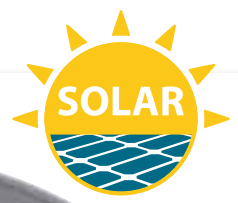

- SOLAR PANEL COVER IN HIGH RESISTANT TEMPERED GLASS
- IP65 IMPROVED IP PROTECTION
- SAME SWITCH FOR ON/OFF AND BATTERY ACTIVATION
- VERY SIMPLE USE

IP65

BATTERY ACTIVATION BOTTON	SELF-ADJUSTING WORKING MODE
 ON/OFF	
OFF MODE TO PRESERVE THE BATTERY	AUTONOMY 46h (at fully charged battery)
	CHARGING TIME 6h at 60.000 Lux (full sunny day)

REPLACEABLE BATTERY	
	<ul style="list-style-type: none"> • LiFePO4 IFR 26650E3400, 3,2V • No risk of explosion • Longer Lifetime
MOTION SENSOR	
	<ul style="list-style-type: none"> • PIR Sensor control • Detection angle 120° • Fields of detection up to 5mt • Active for 25 sec.
SOLAR PANEL	
	<ul style="list-style-type: none"> • 5V/2W • Monocrystalline • High resistant tempered glass



LVD EMC ERP



SOLAR

JOSEPHA

SOLAR MODERN



JS1.242.S3LOP2

**SOLAR MODULE
NEW VERSION**



REFLECTOR - OPTIONAL COLOURS



SOLAR MODERN

JOSEPHA

JOSEPHA SOLAR				
SOLAR MODULE NEW VERSION	BATTERY LiFePO4	SOLAR PANEL	LUMINOUS FLUX	COLOUR TEMPERATURE
	3,4Ah 3,2V	5V/2W	max 280Lm	4000K



AVAILABLE COLORS			
RESIN BODY (MOULDED COLOURS)			REFLECTOR (STANDARD VERSION)
BLACK (A)	GREY (L)	WHITE (W)	OPAL (.OP2)

JOSEPHA 160



**SOLAR MODULE
NEW VERSION**

JS1.114.S3LOP2
OPAL REFLECTOR

Master box: **18pcs**

JOSEPHA 800



**SOLAR MODULE
NEW VERSION**

JS1.242.S3LOP2
OPAL REFLECTOR

- 10 REVIVAL
- 32 GARDEN SMALL
- 48 GARDEN MEDIUM
- 68 GARDEN LARGE
- 84 HALF LANTERN
- 86 BOLLARD
- 92 BOLLARD
- 112 DOWNLIGHT
- 120 UP&DOWN
- 134 FLOODLIGHT
- 142 IN-GROUND
- 148 BRICKLIGHT
- 158 BULKHEAD
- 176 POST
- 184 SOLAR MODERN
- 192 SOLAR CLASSIC
- 194 LAMPS

MADE IN ITALY

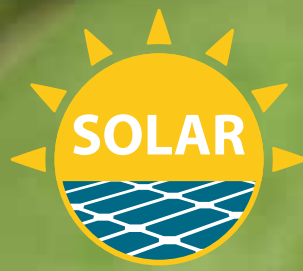

SOLAR

FIORINA

SOLAR MODERN

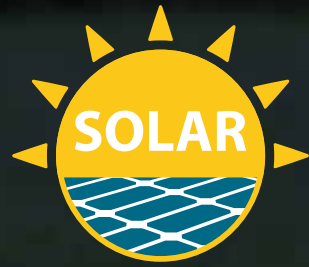

SOLAR MODULE
NEW VERSION



FI1.542.S3L



SOLAR MODERN

FIORINA/FORTUNATO

FIORINA/FORTUNATO SOLAR				
SOLAR MODULE NEW VERSION	BATTERY LiFePO4	SOLAR PANEL	LUMINOUS FLUX	COLOUR TEMPERATURE
	3,4Ah 3,2V	5V/2W	max 280Lm	4000K



AVAILABLE COLORS

RESIN BODY (MOULDED COLOURS)

BLACK (A) GREY (L) WHITE (W)

FIORINA



SOLAR MODULE
NEW VERSION

FI1.542.S3L

SPIKE INSTALLATION GROUND INSTALLATION

160

560

220

DUAL USE

SENSOR

Master box: 6pcs

FORTUNATO



SOLAR MODULE
NEW VERSION

FO1.000.S3L

40

180

SENSOR

Master box: 12pcs

10	REVIVAL
32	GARDEN SMALL
48	GARDEN MEDIUM
68	GARDEN LARGE
84	HALF LANTERN
86	BOLLARD
92	BOLLARD
112	DOWNLIGHT
120	UP&DOWN
134	FLOODLIGHT
142	IN-GROUND
148	BRICKLIGHT
158	BULKHEAD
176	POST
184	SOLAR MODERN
192	SOLAR CLASSIC
194	LAMPS

FELICE

SOLAR MODERN

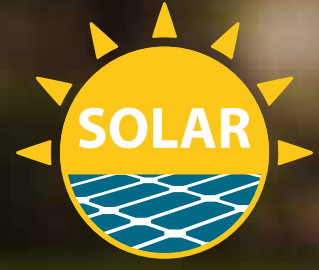

**SOLAR MODULE
NEW VERSION**



FE1.575.S3LOP2



REFLECTOR - OPTIONAL COLOURS

CLEAR	BLUE	GREEN
HX.SOL.RFL	HU.SOL.RFL	HN.SOL.RFL



FELICE SOLAR

SOLAR MODULE NEW VERSION	BATTERY LiFePO4	SOLAR PANEL	LUMINOUS FLUX	COLOUR TEMPERATURE
	3,4Ah 3,2V	5V/2W	max 280Lm	4000K



AVAILABLE COLORS

RESIN BODY (MOULDED COLOURS)			REFLECTOR (STANDARD VERSION)
BLACK (A)	GREY (L)	WHITE (W)	OPAL (.OP2)

FELICE 800

FE1.575.S3LOP2
OPAL REFLECTOR

**SOLAR MODULE
NEW VERSION**

Master box: **4pcs**

FELICE 400

FE1.574.S3LOP2
OPAL REFLECTOR

**SOLAR MODULE
NEW VERSION**

Master box: **12pcs**

FELICE 200

FE1.573.S3LOP2
OPAL REFLECTOR

**SOLAR MODULE
NEW VERSION**

Master box: **18pcs**

FELICE 200 SPIKE

FE1.572.S3LOP2
OPAL REFLECTOR

**SOLAR MODULE
NEW VERSION**

Master box: **18pcs**

10	REVIVAL
32	GARDEN SMALL
48	GARDEN MEDIUM
68	GARDEN LARGE
84	HALF LANTERN
86	BOLLARD
92	BOLLARD
112	DOWNLIGHT
120	UP&DOWN
134	FLOODLIGHT
142	IN-GROUND
148	BRICKLIGHT
158	BULKHEAD
176	POST
184	SOLAR MODERN
192	SOLAR CLASSIC
194	LAMPS

SOLAR

SANTINA

SOLAR MODERN



MADE IN ITALY



UV-TREATED	ANTISHOCK	CE	CB IEC60730 SCHEME	IP55	INSULATION CLASS III
------------	-----------	----	--------------------	------	----------------------



SL1.257.S3LOP2

SOLAR MODULE NEW VERSION



REFLECTOR - OPTIONAL COLOURS

CLEAR	BLUE	GREEN
HX.SOL.RFL	HU.SOL.RFL	HN.SOL.RFL

SOLAR MODERN

SANTINA

SANTINA SOLAR				
SSOLAR MODULE NEW VERSION	BATTERY LiFePO4	SOLAR PANEL	LUMINOUS FLUX	COLOUR TEMPERATURE
	3,4Ah 3,2V	5V/2W	max 280Lm	4000K



AVAILABLE COLORS	
RESIN BODY (MOULDED COLOURS)	REFLECTOR (STANDARD VERSION)
BLACK (A) 	OPAL (.OP2)

SANTINA 800	SANTINA 500	SANTINA 300
<p>SOLAR MODULE NEW VERSION</p> <p></p>		
<p>SL1.257.S3LOP2 OPAL REFLECTOR</p>	<p>SL1.256.S3LOP2 OPAL REFLECTOR</p>	<p>SL1.255.S3LOP2 OPAL REFLECTOR</p>

SANTINA 800 SPIKE	SANTINA 500 SPIKE	SANTINA 300 SPIKE
<p>SOLAR MODULE NEW VERSION</p> <p></p>		
<p>SL1.260.S3LOP2 OPAL REFLECTOR</p>	<p>SL1.259.S3LOP2 OPAL REFLECTOR</p>	<p>SL1.258.S3LOP2 OPAL REFLECTOR</p>

MADE IN ITALY

- 10 REVIVAL
- 32 GARDEN SMALL
- 48 GARDEN MEDIUM
- 68 GARDEN LARGE
- 84 HALF LANTERN
- 86 BOLLARD
- 92 BOLLARD
- 112 DOWNLIGHT
- 120 UP&DOWN
- 134 FLOODLIGHT
- 142 IN-GROUND
- 148 BRICKLIGHT
- 158 BULKHEAD
- 176 POST
- 184 SOLAR MODERN
- 192 SOLAR CLASSIC
- 194 LAMPS

SOLAR

ROSETTA

SOLAR CLASSIC





**SOLAR MODULE
NEW VERSION**

R22.151.S3L



SOLAR CLASSIC

ROSETTA

ROSETTA SOLAR				
SOLAR MODULE NEW VERSION	BATTERY LiFePO4	SOLAR PANEL	LUMINOUS FLUX	COLOUR TEMPERATURE
	3,4Ah 3,2V	5V/2W	max 280Lm	4000K
				



AVAILABLE COLORS	
RESIN BODY	DIFFUSER
	
BLACK (A)	FROSTED (F)

BISSO/ROSETTA

R22.131.S3L

**SOLAR MODULE
NEW VERSION**



 Master box: **12 pcs**

MINILOT/ROSETTA

R22.111.S3L

**SOLAR MODULE
NEW VERSION**



 Master box: **12 pcs**

MIZAR/ROSETTA

R22.151.S3L

**SOLAR MODULE
NEW VERSION**





IAFET/ROSETTA

R22.162.S3L

**SOLAR MODULE
NEW VERSION**





MADE IN ITALY

- 10 REVIVAL
- 32 GARDEN SMALL
- 48 GARDEN MEDIUM
- 68 GARDEN LARGE
- 84 HALF LANTERN
- 86 BOLLARD
- 92 BOLLARD
- 112 DOWNLIGHT
- 120 UP&DOWN
- 134 FLOODLIGHT
- 142 IN-GROUND
- 148 BRICKLIGHT
- 158 BULKHEAD
- 176 POST
- 184 SOLAR MODERN
- 192 SOLAR CLASSIC
- 194 LAMPS



TÜV CERTIFIED LED MODULES



Power surges resistant

- **Wide voltage range (100-240V)** to protect the driver both from voltage droop and voltage overshoot, which are quite frequent in case of outdoor installations.
- **Double 400V capacitors** and multiple resistances to withstand power surges.
- **Silicone paste** to avoid – in case of voltage swings - the vibration of the electronic components of the driver and the consequent risk of components unsoldering.

Heat resistant - Working temperature -30°+80°C

- **Gold wire bonding:** Chips connected by pure gold wires, which are able to withstand at the highest and lowest temperatures and at temperature fluctuations between day and night. The gold wire bonding can grant a lumens maintenance factor > 80%.
- **Silicone paste:** Thermoconductive silicone paste with metal powder inside for helping heat dissipation and avoid overheating problems and for protecting the electronic components in case of high and low temperatures.

Humidity resistant - Weatherproof driver for a longer lifetime

- **Silicone paste:** The driver is fully enclosed in a special silicone paste, which ensures the highest driver protection against moisture and humidity up to 90%, both unavoidable in outdoor installations.



LVD TESTED	LVD Certificate: Fumagalli lamps fulfil the Low Voltage Directive 2014/35/EU, therefore are CE marked and comply with safety requirements like protection against electrical shock, moisture and heat resistance, resistance to flame and ignition.
EMC TESTED	EMC Certificate: Fumagalli lamps meet the Electromagnetic Compatibility Directive 2014/30/EU and its amendments.
NEW ERP	New ERP Attestation of conformity: Fumagalli lamps fulfil the NEW European Ecodesign Directive EU 2019/2020, which sets stricter energy efficiency requirements, new verification tolerances and other factors such as bulb lifetime and warm-up time.
CB	IECEE CB Certificate: Fumagalli lamps meet the International System for Conformity and Certification of Electrotechnical Equipment allowing direct market access in more than 50 countries all over the world.
RoHS REACH COMPLIANT	RoHS REACH compliant: Fumagalli lamps fulfil the RoHS (Restriction of Hazardous Substances) directive 2011/65/EU and its amendments and the REACH regulation (EC) No. 1907/2006, regarding the concentration of Very High Concern Substances (SVHC).



Tested according to :
EN 62560:2012/A1: 2015
IEC/TR 62778:2014
EN 62493:2015



TÜV CERTIFIED LED MODULES

E27 LED A60- CCT SETTABLE

	POWER	8,5 W	11 W	
	LUMINOUS FLUX (Φ TOTAL)	2700 K	840 lm	1100 lm
		4000 K	920 lm	1200 lm
	6500 K	920 lm	1200 lm	
SIZE & SOCKET	 E27		 E27	
VOLTAGE	100-240 V		100-240 V	
FREQUENCY	50/60 Hz		50/60 Hz	
DISPLACEMENT FACTOR	>0,5		>0,7	
PSTLM (NO FLICKER)	< 1		< 1	
SVM	< 0,4		< 0,4	
CRI	> 80		> 80	
SDCM	<6		<6	
LIFETIME	25.000 h		25.000 h	
EFFICIENCY CLASS	F		F	
REF. CODE	H.LED.A60.CCT		H2.LED.A60.CCT	

E27 LED FILAMENT A60

	POWER	6,5 W	
	LUMINOUS FLUX (Φ TOTAL)	2700 K	800 lm
SIZE & SOCKET	 E27		
VOLTAGE	100-240 V		
FREQUENCY	50/60 Hz		
DISPLACEMENT FACTOR	>0,5		
CRI	> 80		
SWITCHING CYCLE	>100.000		
WARM UP TIME	≤ 0,5"		
LIFETIME	25.000 h		
EFFICIENCY CLASS	E		
REF. CODE	H.LED.FIL.3K		

10 REVIVAL
32 GARDEN SMALL
48 GARDEN MEDIUM
68 GARDEN LARGE
84 HALF LANTERN
86 BOLLARD
92 BOLLARD
112 DOWNLIGHT
120 UP&DOWN
134 FLOODLIGHT
142 IN-GROUND
148 BRICKLIGHT
158 BULKHEAD
176 POST
184 SOLAR MODERN
192 SOLAR CLASSIC
194 LAMPS

TÜV CERTIFIED LED MODULES



TÜV CERTIFIED LED MODULES

E27 HIGH POWER LED

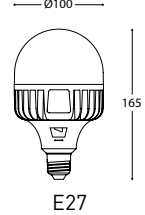
POWER	15 W		30W	
	LUMINOUS FLUX (Φ TOTAL)	3000 K 1545 lm	4000 K 1690 lm	3325lm
SIZE & SOCKET	 E27		 E27	
VOLTAGE	100-240 V		100-240 V	
FREQUENCY	50/60 Hz		50/60 Hz	
DISPLACEMENT FACTOR	>0,7		>0,9	
PSTLM (NO FLICKER)	<1		<1	
SVM	0,4		0,4	
CRI	> 80		> 80	
SDCM	<6		<6	
SWITCHING CYCLE	30.000		30.000	
WARM UP TIME	< 0,5"		< 1"	
LIFETIME	25.000 h		25.000 h	
EFFICIENCY CLASS	F		E	
REF. CODE	H3.LED.HIP.CCT		H2.LED.HIP.CCT	

CCT SETTABLE
3000 K 4000 K
SDCM <6

SILICONE PROTECTION DRIVER

INDOOR & OUTDOOR USE
-30 +80 °C 90% HUMIDITY
VOLTAGE SURGE RESISTANT

ENERG+
FUMAGALLI S.R.L.
H3 LED-HIP.CCT
A B C D E F G
E

30 kWh/1000h

COMPLY WITH:
EU 2019/2015
EU 2019/2020

TUV SUD

CE CB LVD EMC ERP

IECEE
SCHEME

IECEE CB CERTIFICATE:
SG PSB-LE-03835
SG PSB-LE-03834

ENERG+
FUMAGALLI S.R.L.
H2 LED-HIP.CCT
A B C D E F G
E

30 kWh/1000h

COMPLY WITH:
EU 2019/2015
EU 2019/2020

TUV SUD

CE CB LVD EMC ERP

IECEE
SCHEME

IECEE CB CERTIFICATE:
SG PSB-LE-02300A1

E27 HIGH POWER LED

POWER	50 W		60W	
	LUMINOUS FLUX (Φ TOTAL)	3000 K 5850 lm	4000 K 6550 lm	6800 lm
SIZE & SOCKET	 E27		 E27	
VOLTAGE	100-240 V		100-240 V	
FREQUENCY	50/60 Hz		50/60 Hz	
DISPLACEMENT FACTOR	>0,9		>0,9	
PSTLM (NO FLICKER)	<1		<1	
SVM	0,4		0,4	
CRI	> 80		> 80	
SDCM	<6		<6	
SWITCHING CYCLE	30.000		30.000	
WARM UP TIME	< 1"		< 0,5"	
LIFETIME	25.000 h		25.000 h	
KELVIN	3000 K	4000 K	3000 K	4000 K
EFFICIENCY CLASS	E		E	
REF. CODE	H.LED.HIP.3K	H.LED.HIP.4K	H4.LED.HIP.3K	H4.LED.HIP.4K

CCT SETTABLE
2700 K 4000 K
SDCM <3

SILICONE PROTECTION DRIVER

INDOOR & OUTDOOR USE
-30 +80 °C 90% HUMIDITY
VOLTAGE SURGE RESISTANT

ENERG+
FUMAGALLI S.R.L.
H3 LED-HIP.CCT
A B C D E F G
E

50 kWh/1000h

COMPLY WITH:
EU 2019/2015
EU 2019/2020

TUV SUD

CE CB LVD EMC ERP

IECEE
SCHEME

IECEE CB CERTIFICATE:
SG PSB-LE-03791
SG PSB-LE-03799

ENERG+
FUMAGALLI S.R.L.
H2 LED-GU10.CCT
A B C D E F G
E

50 kWh/1000h

COMPLY WITH:
EU 2019/2015
EU 2019/2020

TUV SUD

CE CB LVD EMC ERP

IECEE
SCHEME

IECEE CB CERTIFICATE:
SG PSB-LE-02300A1

GU10 LED - CCT SETTABLE

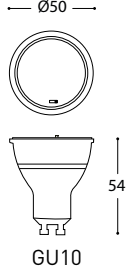
POWER	3,5 W	
	LUMINOUS FLUX (Φ TOTAL)	2700 K 329 lm
SIZE & SOCKET	 GU10	
LUMINOUS FLUX (Φ USE 90°)	260 lm	
VOLTAGE	100-240 V	
FREQUENCY	50/60 Hz	
DISPLACEMENT FACTOR	>0	
PSTLM (NO FLICKER)	<1	
SVM	0,4	
CRI	> 80	
SDCM	<3	
BEAM ANGLE	43°	
SWITCHING CYCLE	> 25.000	
WARM UP TIME	≤ 0,5"	
LIFETIME	25.000 h	
EFFICIENCY CLASS	F	
REF. CODE	H.LED.GU10.CCT	

CCT SETTABLE
2700 K 4000 K
SDCM <3

SILICONE PROTECTION DRIVER

INDOOR & OUTDOOR USE
-30 +80 °C 90% HUMIDITY
VOLTAGE SURGE RESISTANT

ENERG+
FUMAGALLI S.R.L.
H LED-GU10.CCT
A B C D E F G
F

4 kWh/1000h

COMPLY WITH:
EU 2019/2015
EU 2019/2020

TUV SUD

CE CB LVD EMC ERP

IECEE
SCHEME

IECEE CB CERTIFICATE:
SG PSB-LE-02300A1

ENERG+
FUMAGALLI S.R.L.
H LED-GU10.CCT
A B C D E F G
F

4 kWh/1000h

COMPLY WITH:
EU 2019/2015
EU 2019/2020

TUV SUD

CE CB LVD EMC ERP

IECEE
SCHEME

IECEE CB CERTIFICATE:
SG PSB-LE-02300A1

GU10 LED - CCT SETTABLE

POWER	6 W	
	LUMINOUS FLUX (Φ TOTAL)	2700 K 562 lm
SIZE & SOCKET	 GU10	
LUMINOUS FLUX (Φ USE 90°)	440 lm	
VOLTAGE	100-240 V	
FREQUENCY	50/60 Hz	
DISPLACEMENT FACTOR	>0,5	
PSTLM (NO FLICKER)	<1	
SVM	0,9	
CRI	> 80	
SDCM	<3	
BEAM ANGLE	45°	
SWITCHING CYCLE	> 25.000	
WARM UP TIME	≤ 0,5"	
LIFETIME	25.000 h	
EFFICIENCY CLASS	F	
REF. CODE	H2.LED.GU10.CCT	

CCT SETTABLE
2700 K 4000 K
SDCM <3

SILICONE PROTECTION DRIVER

INDOOR & OUTDOOR USE
-30 +80 °C 90% HUMIDITY
VOLTAGE SURGE RESISTANT

ENERG+
FUMAGALLI S.R.L.
H2 LED-GU10.CCT
A B C D E F G
F

6 kWh/1000h

COMPLY WITH:
EU 2019/2015
EU 2019/2020

TUV SUD

CE CB LVD EMC ERP

IECEE
SCHEME

IECEE CB CERTIFICATE:
SG PSB-LE-02300A1

ENERG+
FUMAGALLI S.R.L.
H2 LED-GU10.CCT
A B C D E F G
F

6 kWh/1000h

COMPLY WITH:
EU 2019/2015
EU 2019/2020

TUV SUD

CE CB LVD EMC ERP

IECEE
SCHEME

IECEE CB CERTIFICATE:
SG PSB-LE-02300A1

- 10 REVIVAL
- 32 GARDEN SMALL
- 48 GARDEN MEDIUM
- 68 GARDEN LARGE
- 84 HALF LANTERN
- 86 BOLLARD
- 92 BOLLARD
- 112 DOWNLIGHT
- 120 UP&DOWN
- 134 FLOODLIGHT
- 142 IN-GROUND
- 148 BRICKLIGHT
- 158 BULKHEAD
- 176 POST
- 184 SOLAR MODERN
- 192 SOLAR CLASSIC
- 194 LAMPS



GX53 LED Ø75mm- CCT SETTABLE

	POWER	3 W	
	LUMINOUS FLUX (Φ TOTAL)	3000 K	405 lm
		4000 K	410 lm
	6500 K	410 lm	
SIZE & SOCKET	<p>Ø75 20 GX53</p>		
<p>CCT SETTABLE</p> <p>3000 K 4000 K 6500 K</p> <p>SDCM <6</p> <p>ENERG+</p> <p>FUMAGALLI S.R.L. H4LED.G53.CCT</p> <p>3 kWh/1000h</p> <p>INDOOR & OUTDOOR USE</p> <p>-30 +80 °C 90% HUMIDITY</p> <p>VOLTAGE SURGE RESISTANT</p> <p>COMPLY WITH: EU 2019/2015 EU 2019/2020</p> <p>CE LVD EMC CB ERP</p> <p>IECEE CB CERTIFICATE: SG PSB-LE-03887</p>	LUMINOUS FLUX (Φ USE 120°)	335 lm	
	VOLTAGE	100-240 V	
	FREQUENCY	50/60 Hz	
	PSTLM (NO FLICKER)	<1	
	SVM	0,4	
	CRI	> 80	
	SDCM	<6	
	BEAM ANGLE	112°	
	SWITCHING CYCLE	> 30.000	
	WARM UP TIME	0s	
	LIFETIME	25.000 h	
	EFFICIENCY CLASS	E	
	REF. CODE	H.LED.G53.CCT	

GX53 LED Ø180mm- CCT SETTABLE

	POWER	11,3 W	
	LUMINOUS FLUX (Φ TOTAL)	2700 K	1380 lm
		4000 K	1510 lm
	6500 K	1510 lm	
SIZE & SOCKET	<p>Ø183 - 32 - GX53</p>		
<p>CCT SETTABLE</p> <p>2700 K 4000 K 6500 K</p> <p>SDCM <6</p> <p>ENERG+</p> <p>FUMAGALLI S.R.L. H4LED.G53.CCT</p> <p>12 kWh/1000h</p> <p>INDOOR & OUTDOOR USE</p> <p>-30 +80 °C 90% HUMIDITY</p> <p>VOLTAGE SURGE RESISTANT</p> <p>COMPLY WITH: EU 2019/2015 EU 2019/2020</p> <p>CE LVD EMC CB ERP</p> <p>IECEE CB CERTIFICATE: SG PSB-LE-03936</p>	LUMINOUS FLUX (Φ USE 120°)	1100 lm	
	VOLTAGE	100-240 V	
	FREQUENCY	50/60 Hz	
	DISPLACEMENT FACTOR	>0,7	
	PSTLM (NO FLICKER)	<1	
	SVM	0,4	
	CRI	> 80	
	SDCM	<6	
	BEAM ANGLE (FWHM)	110°	
	SWITCHING CYCLE	> 25.000	
	WARM UP TIME	≤ 0,5"	
	LIFETIME	25.000 h	
	EFFICIENCY CLASS	E	
	REF. CODE	H4.LED.G53.CCT	

GX53 LED Ø100mm - CCT SETTABLE

	POWER	10W	
	LUMINOUS FLUX (Φ TOTAL)	3000 K	1190 lm
		4000 K	1290 lm
	6500 K	1210 lm	
SIZE & SOCKET	<p>Ø100 -37- GX53</p>		
<p>CCT SETTABLE</p> <p>3000 K 4000 K 6500 K</p> <p>SDCM <6</p> <p>ENERG+</p> <p>FUMAGALLI S.R.L. H3LED.G53.CCT</p> <p>10 kWh/1000h</p> <p>INDOOR & OUTDOOR USE</p> <p>-30 +80 °C 90% HUMIDITY</p> <p>VOLTAGE SURGE RESISTANT</p> <p>COMPLY WITH: EU 2019/2015 EU 2019/2020</p> <p>CE LVD EMC CB ERP</p> <p>IECEE CB CERTIFICATE: SG PSB-LE-03887</p>	LUMINOUS FLUX (Φ USE 120°)	975 lm	
	VOLTAGE	100-240 V	
	FREQUENCY	50/60 Hz	
	DISPLACEMENT FACTOR	>0,5	
	PSTLM (NO FLICKER)	< 1	
	SVM	0,4	
	CRI	> 80	
	SDCM	<6	
	BEAM ANGLE	112°	
	SWITCHING CYCLE	> 30.000	
	WARM UP TIME	0s	
	LIFETIME	25.000 h	
	EFFICIENCY CLASS	E	
	REF. CODE	H3.LED.G53.CCT	

GX53 LED Ø180mm- CCT SETTABLE

	POWER	17 W	
	LUMINOUS FLUX (Φ TOTAL)	2700 K	2070 lm
		4000 K	2350 lm
	6500 K	2350 lm	
SIZE & SOCKET	<p>Ø183 - 32 - GX53</p>		
<p>CCT SETTABLE</p> <p>2700 K 4000 K 6500 K</p> <p>SDCM <6</p> <p>ENERG+</p> <p>FUMAGALLI S.R.L. H5LED.G53.CCT</p> <p>12 kWh/1000h</p> <p>INDOOR & OUTDOOR USE</p> <p>-30 +80 °C 90% HUMIDITY</p> <p>VOLTAGE SURGE RESISTANT</p> <p>COMPLY WITH: EU 2019/2015 EU 2019/2020</p> <p>CE LVD EMC CB ERP</p> <p>IECEE CB CERTIFICATE: SG PSB-LE-03936</p>	LUMINOUS FLUX (Φ USE 120°)	1660 lm	
	VOLTAGE	100-240 V	
	FREQUENCY	50/60 Hz	
	DISPLACEMENT FACTOR	>0,7	
	PSTLM (NO FLICKER)	<1	
	SVM	0,4	
	CRI	> 80	
	SDCM	<6	
	BEAM ANGLE (FWHM)	108°	
	SWITCHING CYCLE	> 25.000	
	WARM UP TIME	≤ 0,5"	
	LIFETIME	25.000 h	
	EFFICIENCY CLASS	E	
	REF. CODE	H5.LED.G53.CCT	

GARDEN CLASSIC



GARDEN MODERN

SOLAR



10	REVIVAL
32	GARDEN SMALL
48	GARDEN MEDIUM
68	GARDEN LARGE
84	HALF LANTERN
86	BOLLARD
92	BOLLARD
112	DOWNLIGHT
120	UP&DOWN
134	FLOODLIGHT
142	IN-GROUND
148	BRICKLIGHT
158	BULKHEAD
176	POST
184	SOLAR MODERN
192	SOLAR CLASSIC
194	LAMPS

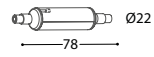

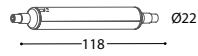

R7s LED 78mm- CCT SETTABLE

SIZE & SOCKET	R7s 	POWER	3,5W
CCT SETTABLE 2700 K 4000 K 6500 K SDCM <4		LUMINOUS FLUX (Φ TOTAL)	2700 K: 325 lm 4000 K: 365 lm 6500 K: 365 lm
		VOLTAGE	100-240 V
		FREQUENCY	50/60 Hz
INDOOR & OUTDOOR USE -30 +80 °C 90% HUMIDITY VOLTAGE SURGE RESISTANT CE LVD EMC ERP ENERG+ FUMAGALLI S.R.L. H7 LED R7S CCT 4 kWh/1000h COMPLY WITH: EU 2019/2015 EU 2019/2020		DISPLACEMENT FACTOR	>0
		PSTLM (NO FLICKER)	<1
		SVM	0,4
		CRI	> 80
		SDCM	<6
		SWITCHING CYCLE	45.000
		WARM UP TIME	≤ 0,5"
		LIFETIME	25.000 h
		EFFICIENCY CLASS	F
		REF. CODE	H7.LED.R7S.CCT

R7s LED 118mm- CCT SETTABLE

SIZE & SOCKET	R7s 	POWER	7,5 W
CCT SETTABLE 2700 K 4000 K 6500 K SDCM <4		LUMINOUS FLUX (Φ TOTAL)	2700 K: 680 lm 4000 K: 775 lm 6500 K: 790 lm
		VOLTAGE	100-240 V
		FREQUENCY	50/60 Hz
INDOOR & OUTDOOR USE -30 +80 °C 90% HUMIDITY VOLTAGE SURGE RESISTANT CE LVD EMC ERP ENERG+ FUMAGALLI S.R.L. H8 LED R7S CCT 8 kWh/1000h COMPLY WITH: EU 2019/2015 EU 2019/2020		DISPLACEMENT FACTOR	>0,5
		PSTLM (NO FLICKER)	<1
		SVM	0,4
		CRI	> 80
		SDCM	<6
		SWITCHING CYCLE	45.000
		WARM UP TIME	≤ 0,5"
		LIFETIME	25.000 h
		EFFICIENCY CLASS	F
		REF. CODE	H8.LED.R7S.CCT

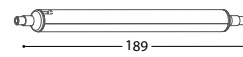
R7s LED 189mm- CCT SETTABLE

SIZE & SOCKET	R7s 	POWER	10,5 W
CCT SETTABLE 2700 K 4000 K 6500 K SDCM <4		LUMINOUS FLUX (Φ TOTAL)	2700 K: 1000 lm 4000 K: 1130 lm 6500 K: 1160 lm
		VOLTAGE	100-240 V
		FREQUENCY	50/60 Hz
INDOOR & OUTDOOR USE -30 +80 °C 90% HUMIDITY VOLTAGE SURGE RESISTANT CE LVD EMC ERP ENERG+ FUMAGALLI S.R.L. H9 LED R7S CCT 11 kWh/1000h COMPLY WITH: EU 2019/2015 EU 2019/2020		DISPLACEMENT FACTOR	>0,7
		PSTLM (NO FLICKER)	<1
		SVM	0,4
		CRI	> 80
		SDCM	<6
		SWITCHING CYCLE	45.000
		WARM UP TIME	≤ 0,5"
		LIFETIME	25.000 h
		EFFICIENCY CLASS	F
		REF. CODE	H9.LED.R7S.CCT

G9LED

	POWER	1,7 W
	LUMINOUS FLUX (Φ TOTAL)	3000 K: 150 lm 4000 K: 150 lm
	SIZE & SOCKET	
INDOOR & OUTDOOR USE -30 +80 °C 90% HUMIDITY VOLTAGE SURGE RESISTANT CE LVD EMC ERP ENERG+ FUMAGALLI S.R.L. H.LED.G09.3K 2 kWh/1000h COMPLY WITH: EU 2019/2015 EU 2019/2020 IECEE CB CERTIFICATE: SG PSB-LE-02130	VOLTAGE	100-240 V
	FREQUENCY	50/60 Hz
	PSTLM (NO FLICKER)	<1
	SVM	0,9
	CRI	> 80
	SDCM	<6
	SWITCHING CYCLE	>40.000
	WARM UP TIME	≤ 0,5"
	LIFETIME	15.000 h
	REF. CODE	H.LED.G09.3K / H.LED.G09.4K

SOLAR MODULE

	SIZE	
	ENERGY SAVING MODE	LUMEN: 20 AUTONOMY: 46h
	FULL POWER MODE	LUMEN: 280 ACTIVE TIME: 25 sec
	SOLAR PANEL	5V/2W Monocrystalline Antishock material High resistant tempered glass
	CHARGING TIME	6h
	REPLACEABLE BATTERY	LiFeP04 IFR26650E3400, 3.2V No Risk of explosion Longer Lifetime
	PIR SENSOR	Detection angle 120° Fields of detection up to 5 mt Active for 25 sec.
	LED	1 CIRCUITS: SMD 2835 COLOR RENDERING INDEX RA: > 80 SDCM: < 6 LIFETIME: 30.000 h KELVIN: 4000 K
	REF. CODE	H2.LED.SOL.4K

- 10 REVIVAL
- 32 GARDEN SMALL
- 48 GARDEN MEDIUM
- 68 GARDEN LARGE
- 84 HALF LANTERN
- 86 BOLLARD
- 92 BOLLARD
- 112 DOWNLIGHT
- 120 UP&DOWN
- 134 FLOODLIGHT
- 142 IN-GROUND
- 148 BRICKLIGHT
- 158 BULKHEAD
- 176 POST
- 184 SOLAR MODERN
- 192 SOLAR CLASSIC
- 194 LAMPS

TAKE ADVANTAGE OF ALL OUR PROMOTIONS!

GARDEN RANGE **PROMO**

PROJECT RANGE **PROMO**



TO SEE OUR COMPLETE COLLECTION

Ask for our **NEW General Catalogue 2025**
or visit our website at
www.fumagalli.it



FUMAGALLI FACTORY



Assembly and Logistic department upgrade

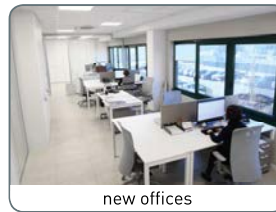

new offices



new exhibition area of 135 sqm



new automated Vertical Warehouse



new warehouse & factory

RESIN MATERIAL ADVANTAGES



NO MAINTENANCE



ANTI-CORROSION



DOUBLE INSULATION



NOT AFFECTED BY CHEMICAL FERTILIZERS



UV-RAY STABILIZED



RECYCLABLE



UV TREATED



DOUBLE INSULATION



ANTI-SHOCK



TEMPERATURE



ENERGY SAVING



RESIDENTIAL



PUBLIC

HOW TO READ THE CODE

DIFFUSER	STRUCTURE	SYSTEM	COLOUR OF THE STRUCTURE	COLOUR OF THE DIFFUSER	ELECTRIFICATION	VARIANT
IDENTIFIES THE DIFFUSER	IDENTIFIES THE STRUCTURE ON WHICH THE DIFFUSER IS MOUNTED (POLE, BRACKET, BASE, SPIKE)	IDENTIFIES THE MULTILIGHT SYSTEM IF PRESENT	IDENTIFIES THE COLOUR OF THE STRUCTURE	IDENTIFIES THE COLOUR OF THE DIFFUSER	IDENTIFIES THE TYPE OF ELECTRIFICATION AND THE EVENTUAL PRESENCE OF BULBS	IDENTIFIES THE PRESENCE OF COMPONENTS SUCH AS AN EVENTUAL LOUVRE OR BACKLIT BASE ON THE BULK-HEAD RANGE
1R3	613	X20	A	Y	B1L	OR1

MADE IN
ITALY

fumagalli[®]
s i n c e 1 9 7 3

Fumagalli S.r.l.

Via Ca' Bassa, 59

21100 Varese - ITALY

Tel. +39.0332.336353

Fax. +39.0332.336358

E-mail customerservice@fumagalli.it



www.fumagalli.it

